

DATA SHEET

vibro-meter®

TQ403, EA403 and IQS450 proximity measurement system

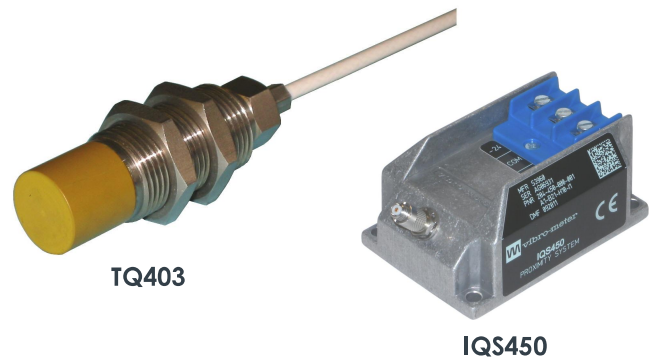

KEY FEATURES AND BENEFITS

- From the vibro-meter® product line
- Non-contact measurement system based on eddy-current principle
- Ex certified versions for use in hazardous areas (potentially explosive atmospheres)
- 5 and 10 m systems
- Temperature-compensated design
- Voltage or current output with protection against short circuits
- Frequency response: DC to 20 kHz (-3 dB)
- Measurement range: 12 mm
- Temperature range: -40 to +180 °C

APPLICATIONS

- Shaft relative vibration and gap/position measurement chains for machinery protection and/or condition monitoring
- Ideal for use with VM600^{Mk2}/VM600 and VibroSmart® machinery monitoring systems

DESCRIPTION

The TQ403, EA403 and IQS450 form a proximity measurement system from Meggitt's vibro-meter® product line. This proximity measurement system allows contactless measurement of the relative displacement of moving machine elements.

TQ4xx-based proximity measurement systems are particularly suitable for measuring the relative vibration and axial position of rotating machine shafts, such as those found in steam, gas and hydraulic turbines, as well as in alternators, turbo-compressors and pumps.



Information contained in this document may be subject to export control regulations of the European Union, USA or other countries. Each recipient of this document is responsible for ensuring that transfer or use of any information contained in this document complies with all relevant export control regulations. ECN N/A.

DESCRIPTION *(continued)*

The system is based around a TQ403 non-contact sensor and an IQS450 signal conditioner. Together, these form a calibrated proximity measurement system in which each component is interchangeable. The system outputs a voltage or a current proportional to the distance between the transducer tip and the target, such as a machine shaft.

The active part of the transducer is a coil of wire that is moulded inside the tip of the device, made of Torlon® (polyamide-imide). The transducer body is made of stainless steel. The target material must, in all cases, be metallic.

The transducer body is available only with metric thread. The TQ403 has an integral coaxial cable, terminated with a self-locking miniature coaxial connector. Various cable lengths (integral and extension) can be ordered.

The IQS450 signal conditioner contains a high-frequency modulator/demodulator that supplies a driving signal to the transducer. This generates

the necessary electromagnetic field used to measure the gap. The conditioner circuitry is made of high-quality components and is mounted in an aluminium extrusion.

The TQ403 transducer can be matched with a single EA403 extension cable to effectively lengthen the front-end. Optional housings, junction boxes and interconnection protectors are available for the mechanical and environmental protection of the connection between the integral and extension cables.

TQ4xx-based proximity measurement systems can be powered by associated machinery monitoring systems such as VM600^{Mk2}/VM600 modules (cards) or VibroSmart® modules, or by another power supply.

For specific applications, contact your local Meggitt representative.

SPECIFICATIONS

Overall proximity measurement system

Operation

Sensitivity

- Ordering option B31 : 1.33 mV/μm (34 mV/mil)
- Ordering option B32 : 0.417 μA/μm (10.6 μA/mil)

Linear measurement range (typical)

- Ordering option B31 : 0.75 to 12.75 mm, corresponding to a -1.6 to -17.6 V output
- Ordering option B32 : 0.75 to 12.75 mm, corresponding to a -15.5 to -20.5 mA output

Linearity

: See **Performance curves on page 5**

Frequency response

: DC to 20 kHz (-3 dB)

Interchangeability of elements

: All components in system are interchangeable

SPECIFICATIONS *(continued)*

Environmental

Potentially explosive atmospheres

Available in Ex approved versions for use in hazardous locations

Type of protection Ex i: intrinsic safety (ordering option A2)		
Europe	EC type examination certificate	LCIE 11 ATEX 3091 X II 1G (Zones 0, 1, 2) Ex ia IIC T6...T3 Ga
International	IECEX certificate of conformity	IECEX LCI 11.0061X Ex ia IIC T6...T3 Ga
North America	cCSAus certificate of compliance	cCSAus 1514309 Class I, Divisions 1 and 2, Groups A, B, C, D Ex ia
South Korea	KGS certificate of conformity	KGS 15-GA4BO-0664X Ex ia IIC T6 to T3
Russian Federation	EAЭC RU certificate of conformity	EAЭC RU C-CH.AΔ07.B.03003/21 0Ex ia IIC T6...T3 Ga X

Type of protection Ex nA: non-sparking (ordering option A3)		
Europe	Voluntary type examination certificate	LCIE 11 ATEX 1010 X II 3G (Zone 2) Ex nA II T6...T3 Gc
International	IECEX certificate of conformity	IECEX LCI 11.0063X Ex nA II T6...T3 Gc
North America	cCSAus certificate of compliance	cCSAus 1514309 Class I, Division 2, Groups A, B, C, D
Russian Federation	EAЭC RU certificate of conformity**	EAЭC RU C-CH.AΔ07.B.03003/21 2Ex nA II T6...T3 Gc X

*Not engraved/marked on the products.

**Not engraved/marked on all products.

-  **For specific parameters of the mode of protection concerned and special conditions for safe use, refer to the Ex certificates that are available from Meggitt SA.**
-  **When using protection mode “Ex nA” (non-sparking), the user must ensure that the signal conditioner is installed in an industrial housing or enclosure that ensures a protection rating of at least IP54 (or equivalent).**
-  **For the most recent information on the Ex certifications that are applicable to this product, refer to the Ex product register (PL-1511) document that is available from Meggitt SA.**

SPECIFICATIONS *(continued)*

Approvals

Conformity	: CE marking, European Union (EU) declaration of conformity. EAC marking, Eurasian Customs Union (EACU) certificate/ declaration of conformity.
Electromagnetic compatibility	: EN 61000-6-2:2005. EN 61000-6-4:2007 + A1:2011. TR CU 020/2011.
Electrical safety	: EN 61010-1:2010
Environmental management	: RoHS compliant (2011/65/EU)
Hazardous areas	: Ex approved versions (see Potentially explosive atmospheres on page 3)
Russian federal agency for technical regulation and metrology (Rosstandart)	: Pattern approval certificate No 60859-15

System calibration

Calibration temperature	: +23°C ±5°C
Target material	: VCL 140 steel (1.7225)

Note: If special calibration is required, please define the alloy precisely or supply a sample of alloy (minimum: Ø60 mm / 1 cm thick) according to Meggitt SA drawing number PZ 7009/1.

Total system length

The total system length (TSL) is the sum of the length of the TQ4xx transducer's integral cable and the length of the EA40x extension cable. The supported TSLs can be obtained from different combinations of cables.

Total system lengths

• 5 m	: 1.0 m integral cable + 4.0 m extension cable. 5.0 m integral cable with no extension cable.
• 10 m	: 1.0 m integral cable + 9.0 m extension cable. 5.0 m integral cable + 5.0 m extension cable. 10.0 m integral cable with no extension cable.

Note: The combination of cables selected for a particular total system length depends on the application. For example, to obtain the optimum location for the separation between the integral and extension cables or to eliminate the requirement for an extension cable.

Total system length trimming

Due to the characteristics of the coaxial cable, an "electrical trimming" of the nominal length of extension cables is necessary to optimize the system performance and the transducer interchangeability.

TSL for a 5 m measurement chain	: 4.4 m minimum
TSL for a 10 m measurement chain	: 8.8 m minimum

SPECIFICATIONS (continued)

Performance curves for TQ403 with IQS450

Typical gap error (μm)
referenced to 1.33 mV/ μm
(0.417 $\mu\text{A}/\mu\text{m}$) line

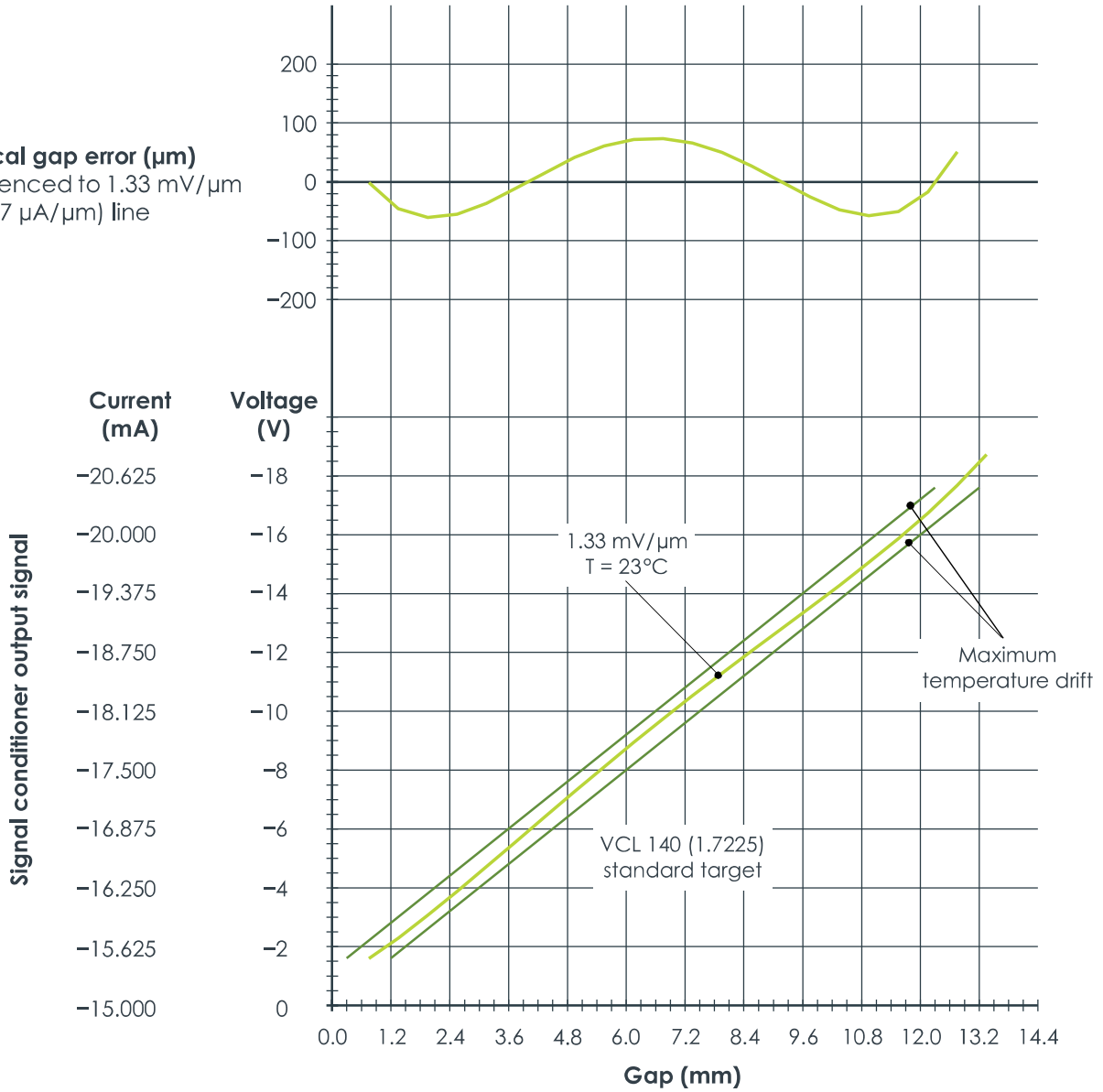

Proximity transducer: TQ403
 Signal conditioner: IQS450
 Standard target material: VCL 140 (1.7225)
 Equivalent materials: A 37.11 (1.0065), AFNOR 40 CD4, AISI 4140

SPECIFICATIONS *(continued)*

TQ403 proximity transducer and EA403 extension cable

General

Transducer input requirements : High-frequency power source from an IQS450 signal conditioner

Environmental

Temperature ranges

- Transducer : -40 to +180°C with drift <5% (operating).
+180 to +220°C with drift >5% (short-term survival).

- Transducer and cable : **-40 to +195°C if used in an Ex Zone**

- Cable, connector and optional protection : -40 to +200°C

Protection rating (according to IEC 60529) : The head of the proximity transducer (transducer tip and integral cable) is rated IP68

Vibration (according to IEC 60068-2-26) : 5 g peak between 10 and 500 Hz

Shock acceleration (according to IEC 60068-2-27) : 15 g peak (half sine-wave, 11 ms duration)

Physical characteristics

Transducer construction : Wire coil Ø18 mm, Teflon (polyamide-imide) tip, encapsulated in MAZ (1.4305) stainless steel body with high-temperature epoxy glue

Integral and extension cables : FEP covered 70 Ω coaxial cable, Ø3.6 mm

Connectors : Self-locking miniature coaxial connectors.
Note: When connecting, these should be hand-tightened until locked.

Optional protection

- Flexible stainless steel hose (protection tube) : The stainless steel hose provides additional mechanical protection but is not leak-tight

- FEP sheath (extruded fluorinated ethylene propylene) : The FEP sheath provides resistance to almost all chemicals and low permeability to liquids, gases and moisture. It is also flexible, low friction and mechanically tough.

SPECIFICATIONS *(continued)*

IQS450 signal conditioner

Output

Voltage output, 3-wire configuration

- Voltage at min. gap : -1.6 V
- Voltage at max. gap : -17.6 V
- Dynamic range : 16 V
- Output impedance : 500 Ω
- Short-circuit current : 45 mA

Current output, 2-wire configuration

- Current at min. gap : -15.5 mA
- Current at max. gap : -20.5 mA
- Dynamic range : 5 mA

Output capacitance : 1 nF

Output inductance : 100 μ H

Supply

Voltage output, 3-wire configuration

- Voltage : -20 to -32 V*
- Current : -13 mA \pm 1 mA (-25 mA max.)

Current output, 2-wire configuration

- Voltage : -20 to -32 V*
- Current : -15.5 to -20.5 mA

Supply input capacitance : 1 nF

Supply input inductance : 100 μ H

Environmental

Temperature ranges

- Operating : -35 to +85°C*
- Storage : -40 to +85°C

Humidity : 95% max. non-condensing.
100% condensing (not submerged).

Protection rating : IP40
(according to IEC 60529)

Vibration : 2 g peak between 10 and 55 Hz
(according to IEC 60068-2-26)

Shock acceleration : 15 g peak (half sine-wave, 11 ms duration)
(according to IEC 60068-2-27)

Physical characteristics

Construction material : Injection-moulded aluminium

Mounting : Two or four M4 screws

Dimensions : See **Mechanical drawings and ordering information on page 11**

*See **Thermal considerations on page 8.**

SPECIFICATIONS *(continued)*

Electrical connections

- Input : Self-locking miniature coaxial connector (female).
Note: When connecting, this should be hand-tightened, until locked.
- Output and power supply : Three screw terminals – wire section 2.5 mm² max.

Weight

- Standard version : 140 g approx.
Ex version : 220 g approx.

Signal conditioner with MA130 mounting adaptor (ordering option I1)

- Universal DIN rail holder type : TSH 35
DIN rail type : TH 35-7.5 and TH 35-15
(according to EN 50022 / IEC 60715)
Dimensions : See **Accessories on page 12**

Thermal considerations

The IQS450 signal conditioner will operate at ambient temperatures as high as 85°C, but to do so, it requires derating of the maximum input voltage. The IQS450 must operate between the minimum supply voltage and the maximum supply voltage, as shown on the following graph.

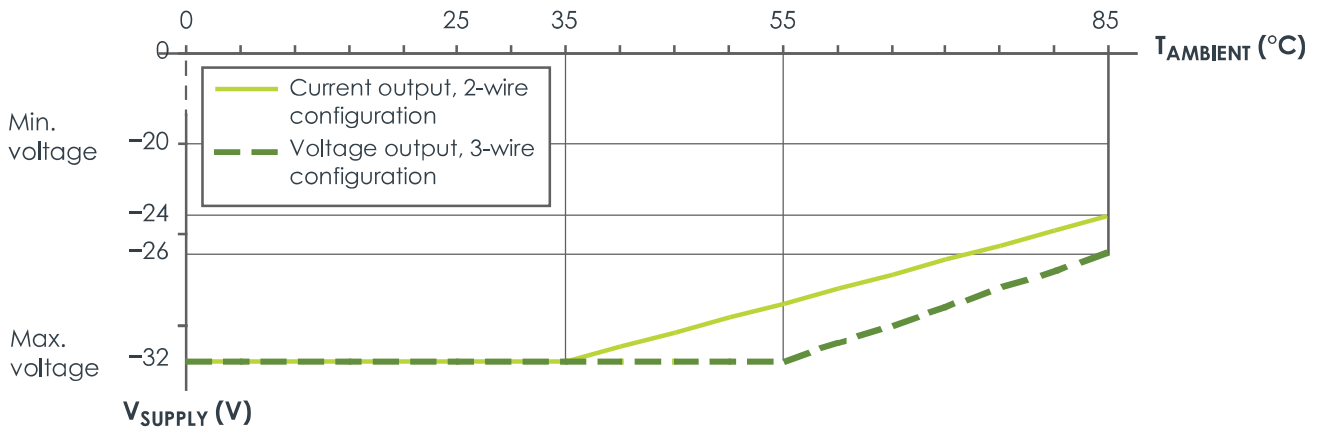

MECHANICAL DRAWINGS AND ORDERING INFORMATION

TQ403 proximity transducer

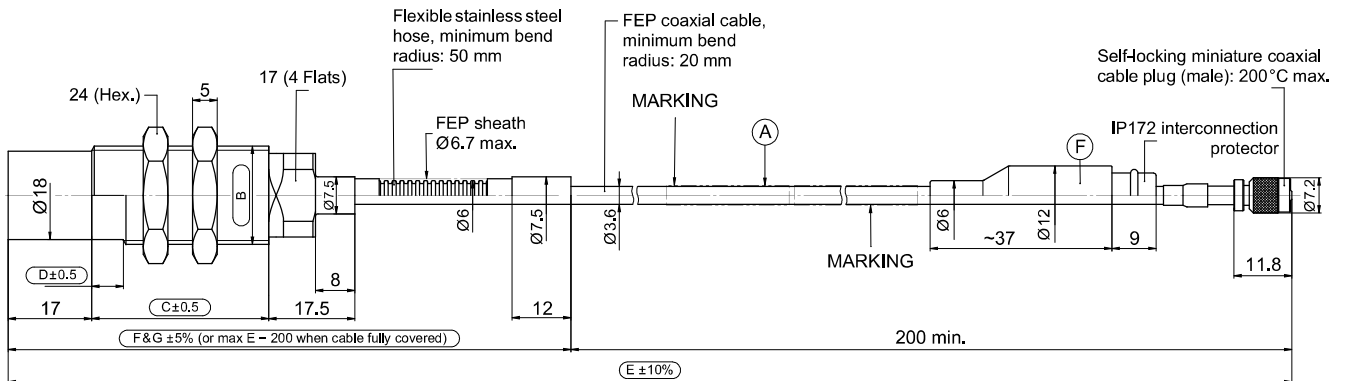

Ordering number:

111 - 403 - 000 - 013 - A - B 1 - C - D - E - F - G - H

Environment (A)	
Standard	1
Explosive Ex i	2
Explosive Ex nA	3

Body thread (B)	
M20 x 1.5	1

Body length (C)	
36 mm	036
50 mm	050
86 mm	086

Unthreaded length (D)	
Each 1 mm, from 0 to 66 mm	
0 mm min.	000
66 mm max.	066

Integral cable length (E)	
1 m ±100 mm	010
5 m ±500 mm	050
10 m ±1000 mm	100

Optional protection (F) See note 1		
Cable	Connector	
None	None	0
Flexible hose	None	1
Flexible hose with FEP sheath	None	2
Movable flexible hose	None	3
Movable flexible hose with FEP sheath	None	4
None	IP172	5
Flexible hose	IP172	6
Flexible hose with FEP sheath	IP172	7
Movable flexible hose	IP172	8
Movable flexible hose with FEP sheath	IP172	9

Flexible hose length (G) See note 1	
Each 0.1 m, from 0 to 9.8 m. G min. = C + 100 mm.	
None	000
0.1 m min.	001
9.8 m max.	098

Total system length (H) See note 2	
5 m	05
10 m	10

Notes

All dimensions are in mm unless otherwise stated.

- When optional protection such as a flexible stainless steel hose with or without an FEP sheath is ordered:
Flexible hose length (G) min. = Body length (C) + 100 mm.
Flexible hose length (G) max. = Integral cable length (E) - 200 mm, for an integral cable that is protected to the maximum extent possible ("cable fully covered").
- The Total system length (H) = TQ403 integral cable length (E) + EA403 extension cable length.
For information on combining integral and extension cables to obtain a particular total system length, see **Total system length on page 4**. For information on cable length tolerances, see **Total system length trimming on page 4**.

MECHANICAL DRAWINGS AND ORDERING INFORMATION (continued)

EA403 extension cable

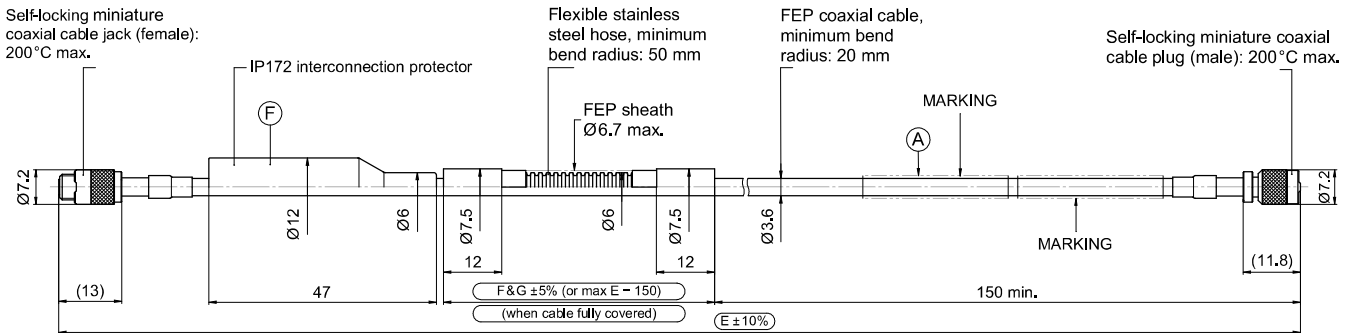

Ordering number: 913 - 403 - 000 - 013 - **A** - **E** - **F** - **G**

Environment (A)	
Standard	1
Explosive Ex i	2
Explosive Ex nA	3

Extension cable length (E) See note 1	
4.0 m ±400 mm	040
5.0 m ±500 mm	050
9.0 m ±900 mm	090

Flexible hose length (G)	
Each 0.1 m, from 0 to 8.8 m	
000	None
001	0.1 m min.
088	8.8 m max.

Optional protection (F) See note 2		
Cable	Connector	
None	None	0
Flexible hose	None	1
Flexible hose with FEP sheath	None	2
None	IP172	5
Flexible hose	IP172	6
Flexible hose with FEP sheath	IP172	7

Notes

All dimensions are in mm unless otherwise stated.

1. The total system length = TQ403 integral cable length + EA403 extension cable length (E).

For information on combining integral and extension cables to obtain a particular total system length, see

Total system length on page 4. For information on cable length tolerances, see **Total system length trimming on page 4.**

2. When optional protection such as a flexible stainless steel hose with or without an FEP sheath is ordered:

Flexible hose length (G) max. = EA403 extension cable length (E) - 150 mm, for an extension cable that is protected to the maximum extent possible ("cable fully covered").

MECHANICAL DRAWINGS AND ORDERING INFORMATION (continued)

IQS450 signal conditioner

Signal conditioner only
(ordering option I0)

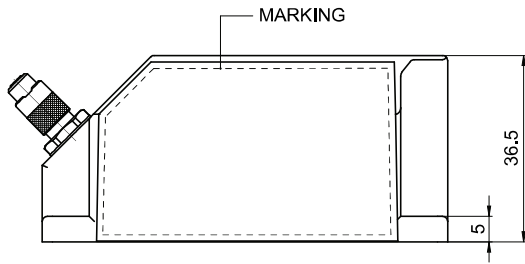

Signal conditioner
with MA130 mounting adaptor
(ordering option I1)

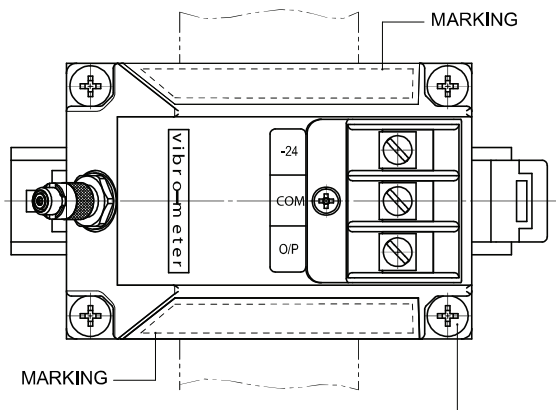
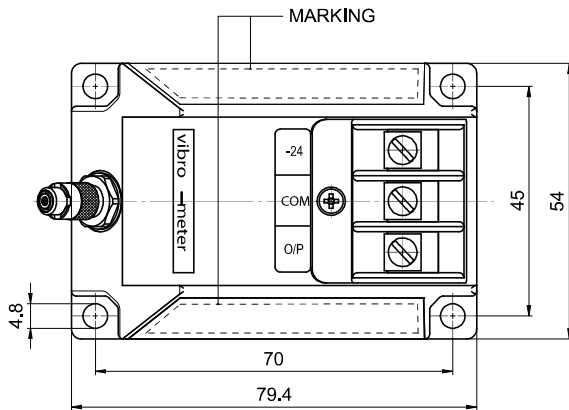
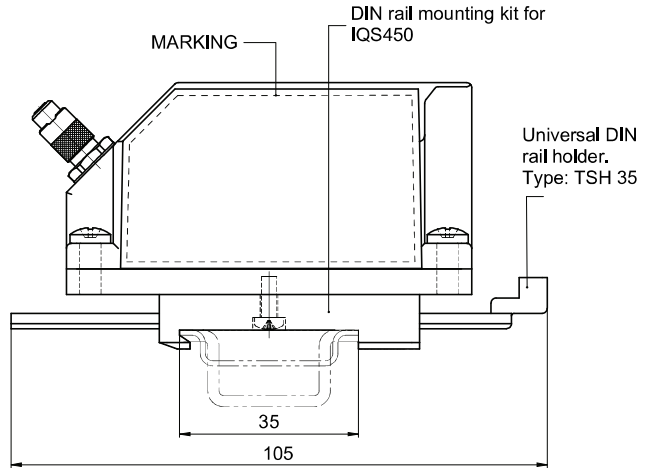

Note: All dimensions are in mm unless otherwise stated.

Self-tapping cross-head (Phillips) screws:
Type: WN 1411, KA40x10
Mounting torque: 0.6 N•m

Ordering number: 204 - 450 - 000 - 002 - A - B - H - I

Environment (A)	
Standard	1
Explosive Ex i	2
Explosive Ex nA	3

Measurement range	Sensitivity (B)	
12 mm	1.33 mV/μm	31
	0.417 μA/μm	32

Installation (I)	
0	Signal conditioner only
1	Signal conditioner assembled on MA130 mounting adaptor

Total system length (H)	
05	5 m
10	10 m

ACCESSORIES

ABA17x	Industrial housings	: Refer to corresponding data sheets
IP172	Interconnection protection	: Refer to corresponding data sheet
JB118	Junction box	: Refer to corresponding data sheet
KS107	Flexible conduit	: Refer to corresponding data sheet
MA130	Mounting adaptor	: See below
SG1xx	Cable feedthroughs	: Refer to corresponding data sheets

MA130 mounting adaptor (for IQS450)

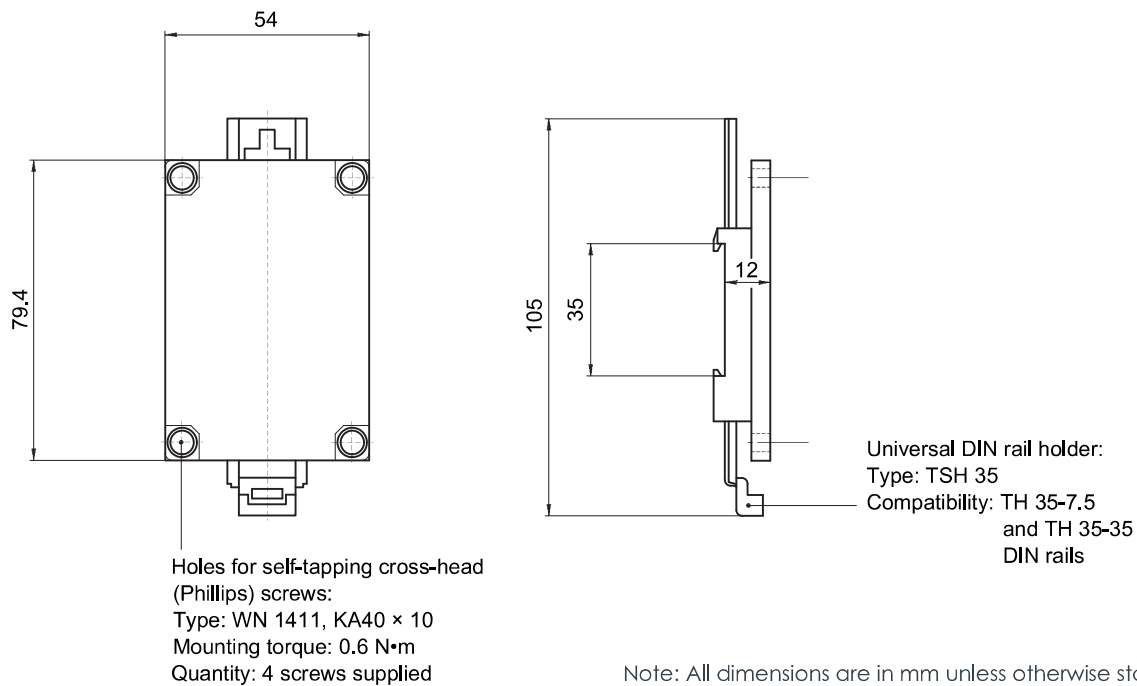

Note: All dimensions are in mm unless otherwise stated.

Ordering number (PNR): 809-130-000-011

RELATED PRODUCTS

TQ401, EA401 and IQS450	Proximity measurement system (2 mm measurement range)	: Refer to corresponding data sheet
TQ402/TQ412, EA402 and IQS450	Proximity measurement system (2 or 4 mm measurement range)	: Refer to corresponding data sheet
TQ422/TQ432, EA402 and IQS450	Proximity measurement system (2 or 4 mm measurement range, high-pressure applications)	: Refer to corresponding data sheet
TQ423, EA403 and IQS450	Proximity measurement system (12 mm measurement range, high-pressure applications)	: Refer to corresponding data sheet
TQ442, EA402 and IQS450	Proximity measurement system (2 or 4 mm measurement range, right-angle (90°) mount)	: Refer to corresponding data sheet

Meggitt (Meggitt PLC) is a leading international engineering company, headquartered in England, that designs and delivers high-performance components and subsystems for aerospace, defence and selected energy markets. Meggitt comprises four customer-aligned divisions: Airframe Systems, Engine Systems, Energy & Equipment and Services & Support.

The Energy & Equipment division includes the Energy Sensing and Controls product group that specialises in sensing and monitoring solutions for a broad range of energy infrastructure, and control valves for industrial gas turbines, primarily for the Power Generation, Oil & Gas and Services markets. Energy & Equipment is headquartered in Switzerland (Meggitt SA) and incorporates the vibro-meter® product line, which has over 65 years of sensor and systems expertise and is trusted by original equipment manufacturers (OEMs) globally.



All information in this document, such as descriptions, specifications, drawings, recommendations and other statements, is believed to be reliable and is stated in good faith as being approximately correct, but is not binding on Meggitt (Meggitt SA) unless expressly agreed in writing. Before acquiring and/or using this product, you must evaluate it and determine if it is suitable for your intended application. You should also check our website at www.meggittsensing.com/energy for any updates to data sheets, certificates, product drawings, user manuals, service bulletins and/or other instructions affecting the product.

Unless otherwise expressly agreed in writing with Meggitt SA, you assume all risks and liability associated with use of the product. Any recommendations and advice given without charge, whilst given in good faith, are not binding on Meggitt SA. Meggitt (Meggitt SA) takes no responsibility for any statements related to the product which are not contained in a current Meggitt SA publication, nor for any statements contained in extracts, summaries, translations or any other documents not authored and produced by Meggitt SA.

The certifications and warranties applicable to the products supplied by Meggitt SA are valid only for new products purchased directly from Meggitt SA or from an authorised distributor of Meggitt SA.

In this publication, a dot (.) is used as the decimal separator and thousands are separated by thin spaces. Example: 12345.67890.

Copyright© 2024 Meggitt SA. All rights reserved. The information contained in this document is subject to change without prior notice.

Sales offices

Meggitt has offices in more than 30 countries. For a complete list, please visit our website.



Local representative

Head office

Meggitt SA
Route de Moncor 4
Case postale
1701 Fribourg
Switzerland
Tel: +41 26 407 11 11
Fax: +41 26 407 13 01
energy@ch.meggitt.com
www.meggittsensing.com/energy
www.meggitt.com