

## DATA SHEET

# vibro-meter®

## TQ401, EA401 and IQS450 proximity measurement system

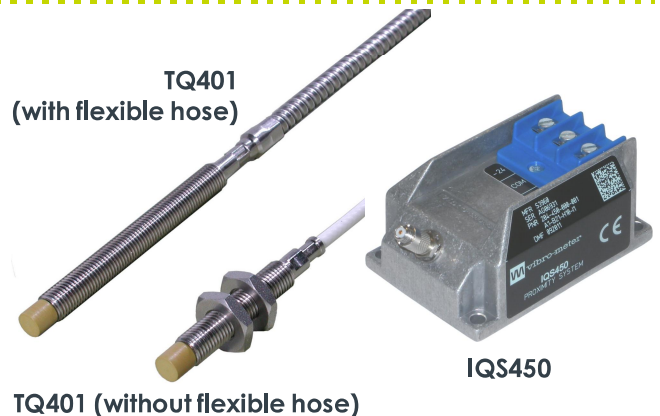

### KEY FEATURES AND BENEFITS

- From the vibro-meter® product line
- Non-contact measurement system based on eddy-current principle
- Ex certified versions for use in hazardous areas (potentially explosive atmospheres)
- TQ401 conforms to API 670 recommendations
- 5 and 10 m systems
- Temperature-compensated design
- Voltage or current output with protection against short circuits
- Frequency response:  
DC to 20 kHz (-3 dB)
- Measurement range:  
2 mm
- Temperature range:  
-40 to +180 °C

### APPLICATIONS

- Shaft relative vibration and gap/position measurement chains for machinery protection and/or condition monitoring
- Ideal for use with VM600<sup>Mk2</sup>/VM600 and VibroSmart® machinery monitoring systems

### DESCRIPTION

The TQ401, EA401 and IQS450 form a proximity measurement system from Meggitt's vibro-meter® product line. This proximity measurement system allows contactless measurement of the relative displacement of moving machine elements.

TQ4xx-based proximity measurement systems are particularly suitable for measuring the relative vibration and axial position of rotating machine shafts, such as those found in steam, gas and hydraulic turbines, as well as in alternators, turbo-compressors and pumps.



Information contained in this document may be subject to export control regulations of the European Union, USA or other countries. Each recipient of this document is responsible for ensuring that transfer or use of any information contained in this document complies with all relevant export control regulations. ECN N/A.

## DESCRIPTION *(continued)*

The system is based around a TQ401 non-contact sensor and an IQS450 signal conditioner. Together, these form a calibrated proximity measurement system in which each component is interchangeable. The system outputs a voltage or current proportional to the distance between the transducer tip and the target, such as a machine shaft.

The active part of the transducer is a coil of wire that is moulded inside the tip of the device, made of Torlon<sup>®</sup> (polyamide-imide). The transducer body is made of stainless steel. The target material must, in all cases, be metallic.

The transducer body is available with metric or imperial thread. The TQ401 has an integral coaxial cable, terminated with a self-locking miniature coaxial connector. Various cable lengths (integral and extension) can be ordered.

The IQS450 signal conditioner contains a high-frequency modulator/demodulator that supplies a driving signal to the transducer. This generates

the necessary electro-magnetic field used to measure the gap. The conditioner circuitry is made of high-quality components and is mounted in an aluminium extrusion.

The TQ401 transducer can be matched with a single EA401 extension cable to effectively lengthen the front-end. Optional housings, junction boxes and interconnection protectors are available for the mechanical and environmental protection of the connection between the integral and extension cables.

TQ4xx-based proximity measurement systems can be powered by associated machinery monitoring systems such as VM600<sup>Mk2</sup>/VM600 modules (cards) or VibroSmart<sup>®</sup> modules, or by another power supply.

For specific applications, contact your local Meggitt representative.

## SPECIFICATIONS

### Overall proximity measurement system

#### Operation

Sensitivity

- Ordering option B11 : 8 mV/ $\mu$ m (200 mV/mil)
- Ordering option B12 : 2.5  $\mu$ A/ $\mu$ m (62.5  $\mu$ A/mil)

Linear measurement range (typical)

- Ordering option B11 : 0.2 to 2.2 mm, corresponding to a -1.6 to -17.6 V output
- Ordering option B12 : 0.2 to 2.2 mm, corresponding to a -15.5 to -20.5 mA output

Linearity

: See **Performance curves on page 5**

Frequency response

: DC to 20 kHz (-3 dB)

Interchangeability of elements

: All components in system are interchangeable

**SPECIFICATIONS** *(continued)*

**Environmental**

**Potentially explosive atmospheres**

Available in Ex approved versions for use in hazardous locations

Type of protection Ex i: intrinsic safety ( <b>ordering option A2</b> )		
Europe	EC type examination certificate	LCIE 11 ATEX 3091 X II 1G (Zones 0, 1, 2) Ex ia IIC T6...T3 Ga
International	IECEX certificate of conformity	IECEX LCI 11.0061X Ex ia IIC T6...T3 Ga
North America	cCSAus certificate of compliance	cCSAus 1514309 Class I, Divisions 1 and 2, Groups A, B, C, D Ex ia
South Korea	KGS certificate of conformity	KGS 15-GA4BO-0664X Ex ia IIC T6 to T3
Russian Federation	EAЭC RU certificate of conformity	EAЭC RU C-CH.AΔ07.B.03003/21 0Ex ia IIC T6...T3 Ga X

Type of protection Ex nA: non-sparking ( <b>ordering option A3</b> )		
Europe	Voluntary type examination certificate	LCIE 11 ATEX 1010 X II 3G (Zone 2) Ex nA II T6...T3 Gc
International	IECEX certificate of conformity	IECEX LCI 11.0063X Ex nA II T6...T3 Gc
North America	cCSAus certificate of compliance	cCSAus 1514309 Class I, Division 2, Groups A, B, C, D
Russian Federation	EAЭC RU certificate of conformity**	EAЭC RU C-CH.AΔ07.B.03003/21 2Ex nA II T6...T3 Gc X

\*Not engraved/marked on the products.

\*\*Not engraved/marked on all products.

-  **For specific parameters of the mode of protection concerned and special conditions for safe use, refer to the Ex certificates that are available from Meggitt SA.**
-  **When using protection mode “Ex nA” (non-sparking), the user must ensure that the signal conditioner is installed in an industrial housing or enclosure that ensures a protection rating of at least IP54 (or equivalent).**
-  **For the most recent information on the Ex certifications that are applicable to this product, refer to the Ex product register (PL-1511) document that is available from Meggitt SA.**

## SPECIFICATIONS *(continued)*

---

### Approvals

Conformity	: CE marking, European Union (EU) declaration of conformity. EAC marking, Eurasian Customs Union (EACU) certificate/ declaration of conformity.
Electromagnetic compatibility	: EN 61000-6-2:2005. EN 61000-6-4:2007 + A1:2011. TR CU 020/2011.
Electrical safety	: EN 61010-1:2010
Environmental management	: RoHS compliant (2011/65/EU)
Hazardous areas	: Ex approved versions (see <b>Potentially explosive atmospheres on page 3</b> )
Russian federal agency for technical regulation and metrology (Rosstandart)	: Pattern approval certificate No 60859-15

### System calibration

Calibration temperature	: +23°C ±5°C
Target material	: VCL 140 steel (1.7225)

Note: If special calibration is required, please define the alloy precisely or supply a sample of alloy (minimum: Ø30 mm / 1 cm thick) according to Meggitt SA drawing number PZ 7009/1.

### Total system length

The total system length (TSL) is the sum of the length of the TQ4xx transducer's integral cable and the length of the EA40x extension cable. The supported TSLs can be obtained from different combinations of cables.

Total system lengths

• 5 m	: 0.5 m integral cable + 4.5 m extension cable. 1.0 m integral cable + 4.0 m extension cable. 1.5 m integral cable + 3.5 m extension cable. 2.0 m integral cable + 3.0 m extension cable. 5.0 m integral cable with no extension cable.
• 10 m	: 0.5 m integral cable + 9.5 m extension cable. 1.0 m integral cable + 9.0 m extension cable. 1.5 m integral cable + 8.5 m extension cable. 2.0 m integral cable + 8.0 m extension cable.

Note: The combination of cables selected for a particular total system length depends on the application. For example, to obtain the optimum location for the separation between the integral and extension cables or to eliminate the requirement for an extension cable.

### Total system length trimming

Due to the characteristics of the coaxial cable, an "electrical trimming" of the nominal length of extension cables is necessary to optimize the system performance and the transducer interchangeability.

TSL for a 5 m measurement chain	: 4.4 m minimum
TSL for a 10 m measurement chain	: 8.5 m minimum

SPECIFICATIONS (continued)

Performance curves for TQ401 with IQS450

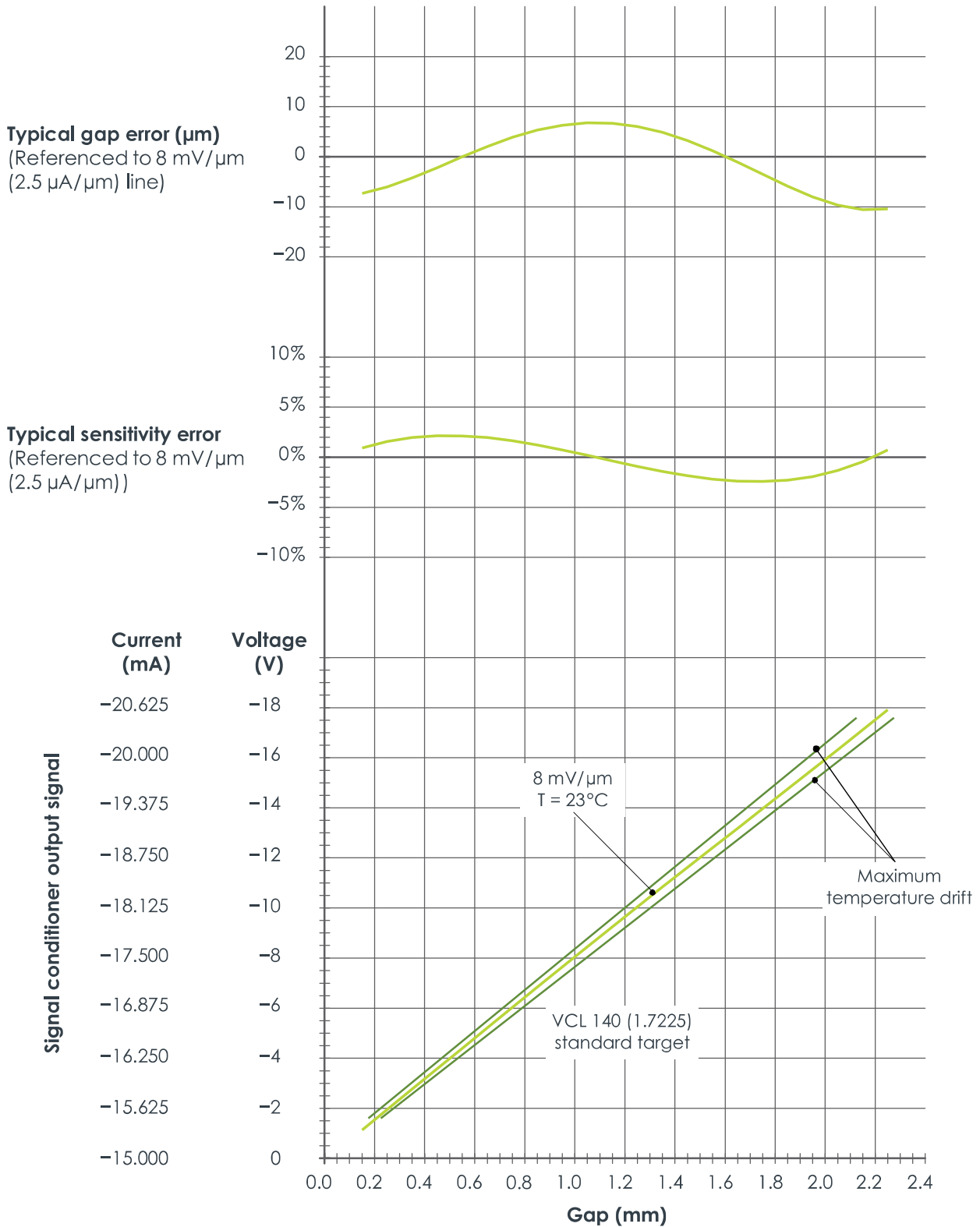

Proximity transducer: TQ401  
 Signal conditioner: IQS450  
 Standard target material: VCL 140 (1.7225)  
 Equivalent materials: A 37.11 (1.0065), AFNOR 40 CD4, AISI 4140

## SPECIFICATIONS *(continued)*

---

### TQ401 proximity transducer and EA401 extension cable

#### General

Transducer input requirements : High-frequency power source from an IQS450 signal conditioner

#### Environmental

Temperature ranges

- Transducer : -40 to +180°C with drift <5% (operating).  
+180 to +220°C with drift >5% (short-term survival).
  - Transducer and cable : **-40 to +195°C if used in an Ex Zone**
  - Cable and connector : -40 to +200°C
  - Heat-shrinkable sleeve : -40 to +135°C
- Protection rating (according to IEC 60529) : The head of the proximity transducer (transducer tip and integral cable) is rated IP68
- Vibration (according to IEC 60068-2-26) : 5 g peak between 10 and 500 Hz
- Shock acceleration (according to IEC 60068-2-27) : 15 g peak (half sine-wave, 11 ms duration)

#### Physical characteristics

- Transducer construction : Wire coil Ø5 mm, Torton (polyamide-imide) tip, encapsulated in stainless steel body (AISI 316L) with high-temperature epoxy glue
- Integral and extension cables : FEP covered 50 Ω coaxial cable, Ø2.65 or Ø3.6 mm
- Connectors : Self-locking miniature coaxial connectors.  
Note: When connecting, these should be hand-tightened until locked.
- Optional protection
- Flexible stainless steel hose (protection tube) : The stainless steel hose provides additional mechanical protection but is not leak-tight
  - Heat-shrinkable sleeve (modified Polyolefin) : The heat-shrinkable sleeve provides additional mechanical and electrical protection

## SPECIFICATIONS *(continued)*

---

### IQS450 signal conditioner

#### Output

Voltage output, 3-wire configuration

- Voltage at min. GAP : -1.6 V
- Voltage at max. GAP : -17.6 V
- Dynamic range : 16 V
- Output impedance : 500  $\Omega$
- Short-circuit current : 45 mA

Current output, 2-wire configuration

- Current at min. GAP : -15.5 mA
- Current at max. GAP : -20.5 mA
- Dynamic range : 5 mA

Output capacitance : 1 nF

Output inductance : 100  $\mu$ H

#### Supply

Voltage output, 3-wire configuration

- Voltage : -20 to -32 V\*
- Current : -13 mA  $\pm$ 1 mA (-25 mA max.)

Current output, 2-wire configuration

- Voltage : -20 to -32 V\*
- Current : -15.5 to -20.5 mA

Supply input capacitance : 1 nF

Supply input inductance : 100  $\mu$ H

#### Environmental

Temperature

- Operating : -35 to +85°C\*
- Storage : -40 to +85°C

Humidity : 95% max. non-condensing.  
100% condensing (not submerged).

Protection rating : IP40  
(according to IEC 60529)

Vibration : 2 g peak between 10 and 55 Hz  
(according to IEC 60068-2-26)

Shock acceleration : 15 g peak (half sine-wave, 11 ms duration)  
(according to IEC 60068-2-27)

#### Physical characteristics

Construction material : Injection-moulded aluminium

Mounting : Two or four M4 screws

Dimensions : See **Mechanical drawings and ordering information on page 11**

\*See **Thermal considerations on page 8.**

**SPECIFICATIONS** *(continued)*

**Electrical connections**

- Input : Self-locking miniature coaxial connector (female).  
Note: When connecting, this should be hand-tightened, until locked.
- Output and power supply : Three screw terminals – wire section 2.5 mm<sup>2</sup> max.

**Weight**

- Standard version : 140 g approx.  
Ex version : 220 g approx.

**Signal conditioner with MA130 mounting adaptor (ordering option I1)**

- Universal DIN rail holder type : TSH 35  
DIN rail type : TH 35-7.5 and TH 35-15  
(according to EN 50022 / IEC 60715)  
Dimensions : See **Accessories on page 12**

**Thermal considerations**

The IQS450 signal conditioner will operate at ambient temperatures as high as 85°C, but to do so, it requires derating of the maximum input voltage. The IQS450 must operate between the minimum supply voltage and the maximum supply voltage, as shown on the following graph.

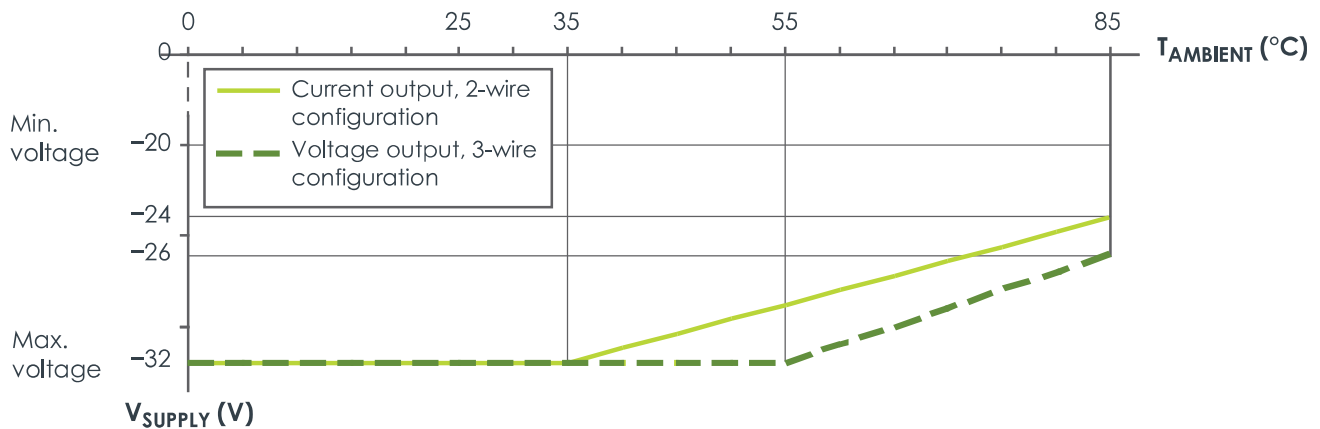

MECHANICAL DRAWINGS AND ORDERING INFORMATION

TQ401 proximity transducer

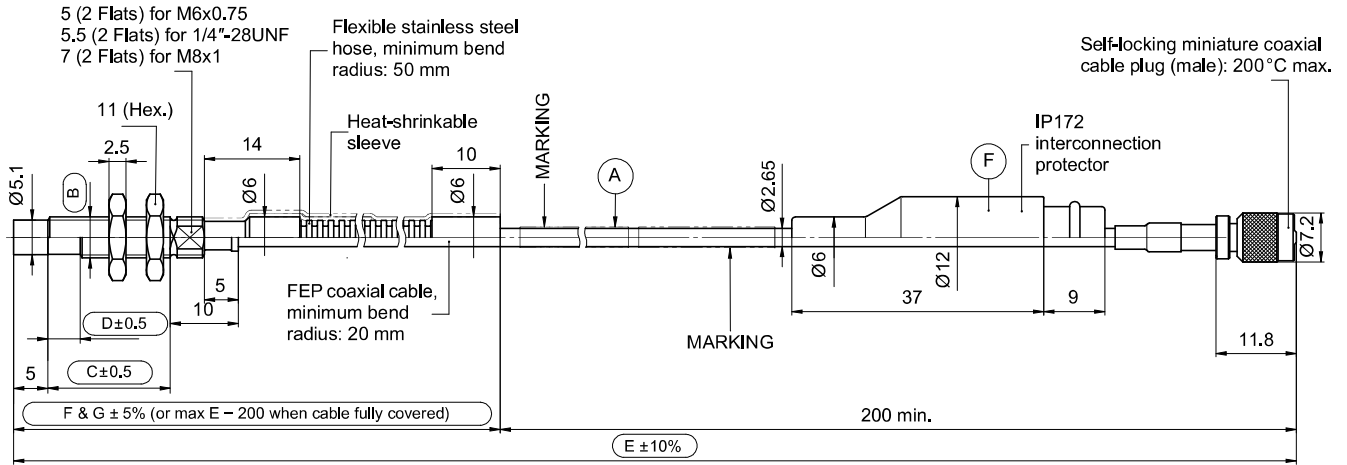

Ordering number:

111 - 401 - 000 - 013 - A - B - C - D - E - F - G - H

Environment (A)	
Standard	1
Explosive Ex i	2
Explosive Ex nA	3

Body thread (B)	
M6 x 0.75	1
M8 x 1	2
1/4"-28UNF	6

Body length (C)	
Each 1 mm, from 18 to 250 mm	
18 mm min.	018
250 mm max.	250

Unthreaded length (D)	
Each 1 mm, from 0 to 60 mm	
0 mm min.	000
60 mm max.	060

Integral cable length (E)	
0.5 m ±50 mm	005
1.0 m ±100 mm	010
1.5 m ±150 mm	015
2.0 m ±200 mm	020
5.0 m ±500 mm	050

Total system length (H)	
See note 2	
05	5 m
10	10 m

Flexible hose length (G)	
See note 1	
Each 0.1 m, from 0.0 to 4.8 m. G min. = C + 100 mm.	
000	None
001	0.1 m min.
048	4.8 m max.

Optional protection (F)		
See note 1		
	Cable	Connector
0	None	None
1	Flexible hose	None
2	Flexible hose with sleeve	None
3	Movable flexible hose	None
4	Movable flexible hose with sleeve	None
5	None	IP172
6	Flexible hose	IP172
7	Flexible hose with sleeve	IP172
8	Movable flexible hose	IP172
9	Movable flexible hose with sleeve	IP172

Notes

- All dimensions are in mm unless otherwise stated.
- When optional protection such as a flexible stainless steel hose with or without a heat-shrinkable sleeve is ordered:  
Flexible hose length (G) min. = Body length (C) + 100 mm.  
Flexible hose length (G) max. = Integral cable length (E) - 200 mm, for an integral cable that is protected to the maximum extent possible ("cable fully covered").
  - The Total system length (H) = TQ401 integral cable length (E) + EA401 extension cable length.  
For information on combining integral and extension cables to obtain a particular total system length, see **Total system length on page 4**.  
For information on cable length tolerances, see **Total system length trimming on page 4**.

MECHANICAL DRAWINGS AND ORDERING INFORMATION (continued)

EA401 extension cable

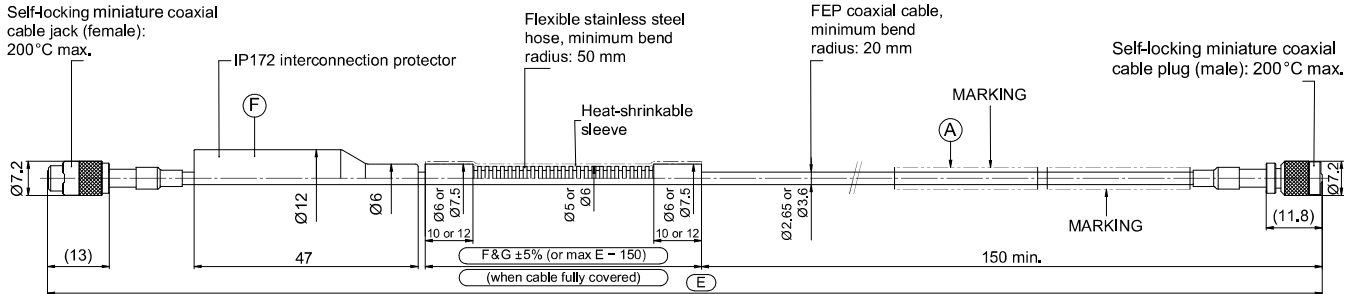

Ordering number: 913 - 401 - 000 - 013 - **A** - **E** - **F** - **G**

Environment (A)	
Standard	1
Explosive Ex i	2
Explosive Ex nA	3

Flexible hose length (G)	
Each 0.1 m, from 0 to 9.3 m	
000	None
001	0.1 m min.
093	9.3 m max.

Extension cable length (E) See note 1			
5 m TSL	Ø2.65	3.0 m ±300 mm	030
		3.5 m ±350 mm	035
		4.0 m ±400 mm	040
		4.5 m ±450 mm	045
10 m TSL	Ø3.6	8.0 m ±1200 mm	080
		8.5 m ±1275 mm	085
		9.0 m ±1350 mm	090
		9.5 m ±1425 mm	095

Optional protection (F) See note 2		
Cable	Connector	
None	None	0
Flexible hose	None	1
Flexible hose with sleeve	None	2
None	IP172	5
Flexible hose	IP172	6
Flexible hose with sleeve	IP172	7

Notes

All dimensions are in mm unless otherwise stated.

1. The total system length = TQ401 integral cable length + EA401 extension cable length (E).

For information on combining integral and extension cables to obtain a particular total system length, see

**Total system length on page 4.** For information on cable length tolerances, see **Total system length trimming on page 4.**

2. When optional protection such as a flexible stainless steel hose with or without a heat-shrinkable sleeve is ordered:

Flexible hose length (G) max. = EA401 extension cable length (E) - 150 mm, for an extension cable that is protected to the maximum extent possible ("cable fully covered").

MECHANICAL DRAWINGS AND ORDERING INFORMATION (continued)

IQS450 signal conditioner

Signal conditioner only  
(ordering option I0)

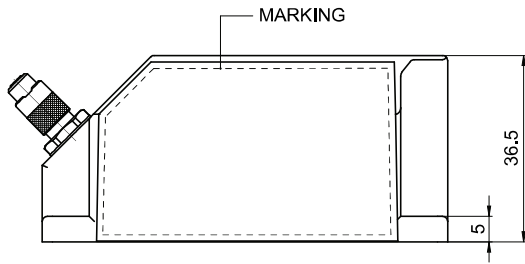

Signal conditioner  
with MA130 mounting adaptor  
(ordering option I1)

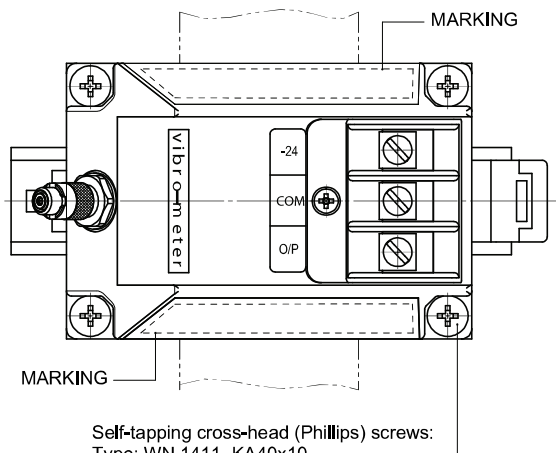
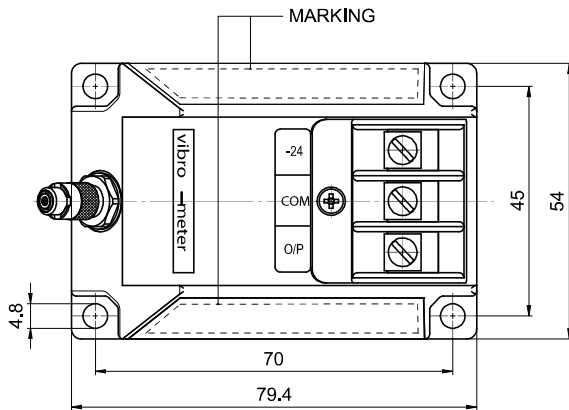
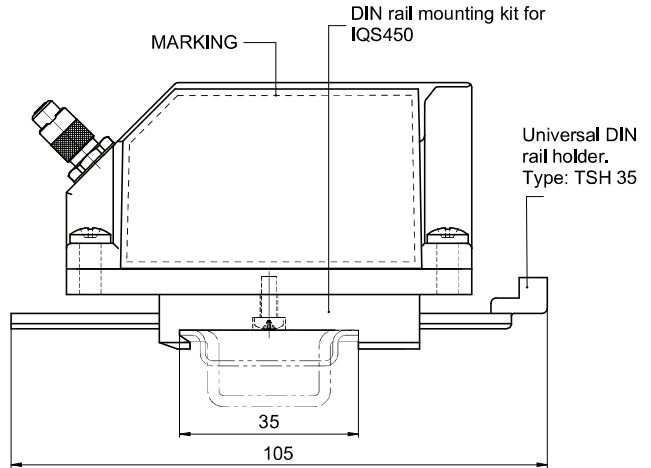

Note: All dimensions are in mm unless otherwise stated.

Self-tapping cross-head (Phillips) screws:  
Type: WN 1411, KA40x10  
Mounting torque: 0.6 N•m

Ordering number: 204 - 450 - 000 - 002 - A - B - H - I

Environment (A)	
Standard	1
Explosive Ex i	2
Explosive Ex nA	3

Measurement range	Sensitivity (B)	
2 mm	8 mV/μm	11
	2.5 μA/μm	12

Installation (I)	
0	Signal conditioner only
1	Signal conditioner assembled on MA130 mounting adaptor

Total system length (H)	
05	5 m
10	10 m

## ACCESSORIES

ABA17x	Industrial housings	: Refer to corresponding data sheet
IP172	Interconnection protection	: Refer to corresponding data sheet
JB118	Junction box	: Refer to corresponding data sheet
KS107	Flexible conduit (protection tube)	: Refer to corresponding data sheet
MA130	Mounting adaptor	: See below
SG1xx	Cable feedthroughs	: Refer to corresponding data sheets

### MA130 mounting adaptor (for IQS450)

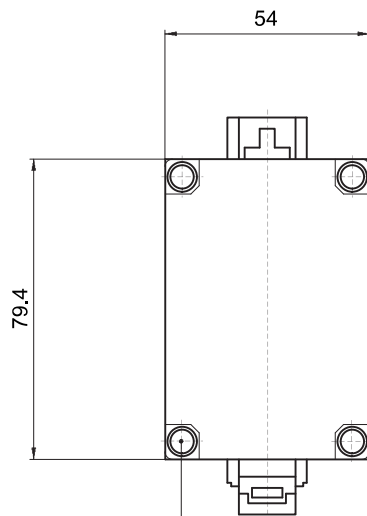

Holes for self-tapping cross-head (Phillips) screws:  
Type: WN 1411, KA40 × 10  
Mounting torque: 0.6 N•m  
Quantity: 4 screws supplied

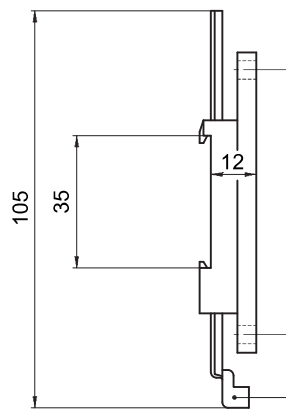

Universal DIN rail holder:  
Type: TSH 35  
Compatibility: TH 35-7.5  
and TH 35-35  
DIN rails

Note: All dimensions are in mm unless otherwise stated.

Ordering number (PNR): 809-130-000-011

## RELATED PRODUCTS

TQ402/TQ412, EA402 and IQS450	Proximity measurement system (2 or 4 mm measurement range)	: Refer to corresponding data sheet
TQ403, EA403 and IQS450	Proximity measurement system (12 mm measurement range)	: Refer to corresponding data sheet
TQ422/TQ432, EA402 and IQS450	Proximity measurement system (2 or 4 mm measurement range, high-pressure applications)	: Refer to corresponding data sheet
TQ423, EA403 and IQS450	Proximity measurement system (12 mm measurement range, high-pressure applications)	: Refer to corresponding data sheet
TQ442, EA402 and IQS450	Proximity measurement system (2 or 4 mm measurement range, right-angle (90°) mount)	: Refer to corresponding data sheet

Meggitt (Meggitt PLC) is a leading international engineering company, headquartered in England, that designs and delivers high-performance components and subsystems for aerospace, defence and selected energy markets. Meggitt comprises four customer-aligned divisions: Airframe Systems, Engine Systems, Energy & Equipment and Services & Support.

The Energy & Equipment division includes the Energy Sensing and Controls product group that specialises in sensing and monitoring solutions for a broad range of energy infrastructure, and control valves for industrial gas turbines, primarily for the Power Generation, Oil & Gas and Services markets. Energy & Equipment is headquartered in Switzerland (Meggitt SA) and incorporates the vibro-meter® product line, which has over 65 years of sensor and systems expertise and is trusted by original equipment manufacturers (OEMs) globally.



All information in this document, such as descriptions, specifications, drawings, recommendations and other statements, is believed to be reliable and is stated in good faith as being approximately correct, but is not binding on Meggitt (Meggitt SA) unless expressly agreed in writing. Before acquiring and/or using this product, you must evaluate it and determine if it is suitable for your intended application. You should also check our website at [www.meggittsensing.com/energy](http://www.meggittsensing.com/energy) for any updates to data sheets, certificates, product drawings, user manuals, service bulletins and/or other instructions affecting the product.

Unless otherwise expressly agreed in writing with Meggitt SA, you assume all risks and liability associated with use of the product. Any recommendations and advice given without charge, whilst given in good faith, are not binding on Meggitt SA. Meggitt (Meggitt SA) takes no responsibility for any statements related to the product which are not contained in a current Meggitt SA publication, nor for any statements contained in extracts, summaries, translations or any other documents not authored and produced by Meggitt SA.

The certifications and warranties applicable to the products supplied by Meggitt SA are valid only for new products purchased directly from Meggitt SA or from an authorised distributor of Meggitt SA.

In this publication, a dot (.) is used as the decimal separator and thousands are separated by thin spaces. Example: 12345.67890.

Copyright© 2024 Meggitt SA. All rights reserved. The information contained in this document is subject to change without prior notice.

## Sales offices

Meggitt has offices in more than 30 countries. For a complete list, please visit our website.



## Local representative

## Head office

Meggitt SA  
Route de Moncor 4  
Case postale  
1701 Fribourg  
Switzerland  
Tel: +41 26 407 11 11  
Fax: +41 26 407 13 01  
[energy@ch.meggitt.com](mailto:energy@ch.meggitt.com)  
[www.meggittsensing.com/energy](http://www.meggittsensing.com/energy)  
[www.meggitt.com](http://www.meggitt.com)