

Technical Data

Original Instructions



Allen-Bradley

by ROCKWELL AUTOMATION

1756 ControlLogix Power Supplies Specifications

Standard Power Supplies	1756-PA72, 1756-PA72K, 1756-PA75, 1756-PA75K, 1756-PB72, 1756-PB72K, 1756-PB75, 1756-PB75K, 1756-PC75, 1756-PH75
Standard Slim Power Supplies	1756-PA50, 1756-PA50K, 1756-PB50, 1756-PB50K
ControlLogix-XT Power Supplies	1756-PAXT, 1756-PBXT
ControlLogix-XT Slim Power Supplies	1756-PA30XT, 1756-PB30XT
Redundant Power Supplies	1756-PA75R, 1756-PA75RK, 1756-PB75R, 1756-PB75RK
Redundant Power Supplies Chassis Adapter	1756-PSCA2, 1756-PSCA2K
ControlLogix-XT Redundant Power Supplies	1756-PAXTR, 1756-PBXTR
ControlLogix-XT Redundant Power Supplies Chassis Adapter	1756-PSCA2XT
Redundant Power Supply Power Cable	1756-CPR2, 1756-CPR2D, 1756-CPR2U

Topic	Page
Summary of Changes	2
Standard AC Power Supplies	3
Standard DC Power Supplies	6
1756 ControlLogix-XT Power Supplies	9
Redundant Power Supplies	12
Power Load and Transformer Sizing	20
Additional Resources	23

Summary of Changes

This publication contains the following new or updated information. This list includes substantive updates only and is not intended to reflect all changes.

Topic	Page
Updated or Added Operating Temperature Environmental Specifications	Throughout
Updated UKCA, Ex, UKEX, IECEx, and CCC Certification Information	Throughout

Standard AC Power Supplies

Mounting Dimensions

1756-PA72, 1756-PA72K, 1756-PA75, 1756-PA72K

1756-PA50, 1756-PA50K

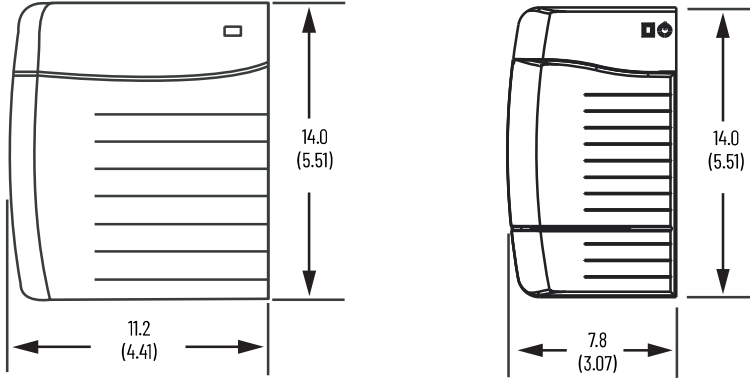

Dimensions are in cm (in.).

Technical Specifications - Standard AC Power Supplies

Attribute	1756-PA50, 1756-PA50K	1756-PA72/C, 1756-PA72K/C	1756-PA75/B, 1756-PA75K/B
Input voltage range ⁽¹⁾	85...265V AC		
Input voltage, nom	120V/240V AC		
Input frequency range	47...63 Hz		
Input power, max	81 W/91VA @ 50 °C (122 °F) 68 W/77VA @ 60 °C (140 °F)	100VA/100 W	
Output power, max	60 W @ 0...50 °C (32...122 °F) ⁽³⁾ 50 W @ 0...60 °C (32...140 °F) ⁽⁴⁾	75 W @ 0...60 °C (32...140 °F) ⁽⁶⁾	
Inrush current, max	20 A		
Hold up time ⁽²⁾	4 cycles @85...265V AC, 50/60 Hz, 60 W 5 cycles @85...265V AC, 50/60 Hz, 50 W	5 cycles @ 85V AC, 50/60 Hz 6 cycles @ 120V AC, 50/60 Hz 6 cycles @ 200V AC, 50/60 Hz 6 cycles @ 240V AC, 50/60 Hz	2 cycles @ 85V AC, 60 Hz 6 cycles @ 120V AC, 60 Hz 20 cycles @ 220V AC, 60 Hz
Current capacity @ 1.2V DC	1.5 A		
Current capacity @ 3.3V DC	2 A	4 A	
Current capacity @ 5.1V DC	8 A @ 50 °C (122 °F) 6 A @ 60 °C (140 °F)	10 A	13 A
Current capacity @ 24V DC	2.5 A @ 50 °C (122 °F) 2.0 A @ 60 °C (140 °F)	2.8 A	
Isolation voltage	250V (continuous), Reinforced Insulation Type, Power Input to Backplane Type tested @ 3150V DC for 60 s	250V (continuous), Reinforced Insulation Type, Power Input to Backplane Type tested at 3500V DC for 60 s	
Weight, approx	0.77 kg (1.7 lb)	0.95 kg (2.10 lb)	
Dimensions (HxWxD), approx	14.0 x 7.8 x 14.5 cm (5.51 x 3.07 x 5.71 in.)	14.0 x 11.2 x 14.5 cm (5.51 x 4.41 x 5.71 in.)	
Module location	Left side of 1756 chassis		
Chassis	1756-A4, 1756-A7, 1756-A10, 1756-A13, 1756-A17		
Chassis compatibility	Series A Series B Series C	Series B Series C	
Wire size	2.5 mm ² (14 AWG) solid or stranded copper wire that is rated at 90 °C (194 °F), or greater, 1.2 mm (3/64 in.) insulation max		
Wire category	1 - on power ports ⁽⁵⁾		

Technical Specifications - Standard AC Power Supplies (Continued)

Attribute	1756-PA50, 1756-PA50K	1756-PA72/C, 1756-PA72K/C	1756-PA75/B, 1756-PA75K/B
Conductor screw torque	0.565 N•m (5 lb•in)		
North American temperature code	T4		
Enclosure type rating	None (open-style)		

- (1) UL certification for 120/240V AC, 50/60 Hz nominal. Rockwell Automation specified 85...265V AC, 47...63 Hz.
- (2) The hold up time is the time between input voltage removal and DC power failure.
- (3) The combination of all output power (5.1V backplane, 24V backplane, 3.3V backplane, and 1.2V backplane) can't exceed 60 W @ 50 °C (122 °F) maximum temperature.
- (4) The combination of all output power (5.1V backplane, 24V backplane, 3.3V backplane, and 1.2V backplane) can't exceed 50 W @ 60 °C (140 °F) maximum temperature.
- (5) Use this conductor category information to plan conductor routing as described in the system level installation manual. See the Industrial Automation Wiring and Grounding Guidelines, publication [1770-4.1](#).
- (6) The combination of all output power (5.1V backplane, 24V backplane, 3.3V backplane, and 1.2V backplane) can't exceed 75 W.

Environmental Specifications - Standard AC Power Supplies

Attribute	1756-PA50, 1756-PA50K	1756-PA72/C, 1756-PA72K/C, 1756-PA75/B, 1756-PA75K/B
Temperature, operating IEC 60068-2-1 (Test Ae, Operating Cold), IEC 60068-2-2 (Test Be, Operating Dry Heat), IEC 60068-2-14 (Test Nb, Operating Thermal Shock)	0 °C < Ta < +60 °C (32 °F < Ta < 140 °F)	
Temperature, surrounding air, max	60 °C (140 °F)	
Temperature, nonoperating IEC 60068-2-1 (Test Ab, Unpackaged Nonoperating Cold), IEC 60068-2-2 (Test Bb, Unpackaged Nonoperating Dry Heat), IEC 60068-2-14 (Test Na, Unpackaged Nonoperating Thermal Shock)	-40...+85 °C (-40...+185 °F)	
Relative humidity IEC 60068-2-30 (Test Db, Unpackaged Damp Heat)	5...95% noncondensing	
Vibration IEC 60068-2-6 (Test Fc, Operating)	2 g @ 10...500 Hz	
Shock, operating IEC 60068-2-27 (Test Ea, Unpackaged Shock)	30 g	
Shock, nonoperating IEC 60068-2-27 (Test Ea, Unpackaged Shock)	50 g ⁽¹⁾	
Emissions	IEC 61000-6-4	
ESD immunity IEC 61000-4-2	6 kV contact discharges 8 kV air discharges	
Radiated RF immunity IEC 61000-4-3	10V/m with 1 kHz sine wave 80% AM from 80...2000 MHz 10V/m with 200 Hz 50% Pulse 100% AM @ 900 MHz 10V/m with 200 Hz 50% Pulse 100% AM @ 1890 MHz 3V/m with 1 kHz sine wave 80% AM from 2000...2700 MHz	
EFT/B immunity IEC 61000-4-4	±4 kV at 5 kHz on power ports	
Surge transient immunity IEC 61000-4-5	±1 kV line-line (DM) and ±2 kV line-earth (CM) on power ports	
Conducted RF immunity IEC 61000-4-6	10V rms with 1 kHz sine wave 80% AM from 150 kHz...80 MHz	
Voltage variation IEC 61000-4-11	30% dips for 1 period at 0° and 180° on AC supply ports 60% dips for 5 and 50 periods on AC supply ports ±10% fluctuations for 15 min on AC supply ports >95% interruptions for 250 periods on AC supply ports	
Damped oscillatory wave immunity IEC 61000-4-18	±2.5 kV line-line (DM) and ±2.5 kV line-earth (CM) on power ports	-

- (1) Series C chassis have a maximum nonoperating shock value of 30 g. If you select a Series C chassis for use with your power supply, you're limited to a maximum nonoperating shock value of 30 g.

Certifications - Standard AC Power Supplies

Certification ⁽¹⁾	1756-PA50, 1756-PA50K	1756-PA72/C, 1756-PA72K/C	1756-PA75/B, 1756-PA75K/B	
UL	-	UL Listed Industrial Control Equipment. See UL File E65584.		
c-UL-us	UL Listed Industrial Control Equipment, which is certified for US and Canada. See UL File E65584. UL Listed for Class I, Division 2 Group A,B,C,D Hazardous Locations, which are certified for U.S. and Canada. See UL File E194810.	-		
UKCA	In conformity with the following UK Statutory Instruments and their amendments: <ul style="list-style-type: none"> • 2016 No. 1091, Electromagnetic Compatibility Regulations • 2016 No. 1101, Electrical Equipment (Safety) Regulations • 2016 No. 1107, Equipment and Protective Systems Intended for Use in Potentially Explosive Atmospheres Regulations • 2012 No. 3032, Restriction of the Use of Certain Hazardous Substances in Electrical and Electronic Equipment 			
CSA	-	CSA Certified Process Control Equipment. See CSA File LR54689C. CSA Certified Process Control Equipment for Class I, Division 2 Group A,B,C,D Hazardous Locations. See CSA File LR69960C.		
FM	FM Approved Equipment for use in Class I Division 2 Group A,B,C,D Hazardous Locations			
CE	European Union 2014/30/EU EMC Directive, compliant with: <ul style="list-style-type: none"> • EN 61326-1; Meas./Control/Lab., Industrial Requirements • EN 61000-6-2; Industrial Immunity • EN 61000-6-4; Industrial Emissions • EN 61131-2; Programmable Controllers (Clause 8, Zone A & B) European Union 2014/35/EU LVD, compliant with: <ul style="list-style-type: none"> • EN 61010-2-201; Control Equipment Safety Requirements 	European Union 2014/30/EU EMC Directive, compliant with: <ul style="list-style-type: none"> • EN 61326-1; Meas./Control/Lab., Industrial Requirements • EN 61000-6-2; Industrial Immunity • EN 61000-6-4; Industrial Emissions • EN 61131-2; Programmable Controllers (Clause 8, Zone A & B) European Union 2014/35/EU LVD, compliant with: <ul style="list-style-type: none"> • EN 61131-2; Programmable Controllers (Clause 11) 		
RCM	Australian Radiocommunications Act, compliant with: <ul style="list-style-type: none"> • EN 61000-6-4; Industrial Emissions 			
KC	Korean Registration of Broadcasting and Communications Equipment, compliant with: <ul style="list-style-type: none"> • Article 58-2 of Radio Waves Act, Clause 3 			
EAC	Russian Customs Union TR CU 020/2011 EMC Technical Regulation Russian Customs Union TR CU 004/2011 LV Technical Regulation			
CCC	CCC 2020122309111830, 2020122309111998, 2020122309113868 CNCA-C23-01 强制性产品认证实施规则 防爆电气 CNCA-C23-01 CCC Implementation Rule Explosion-Proof Electrical Products			

(1) See the Product Certification link at rok.auto/certifications for Declarations of Conformity, Certificates, and other certification details.

Standard DC Power Supplies

Mounting Dimensions

1756-PB72, 1756-PB72K, 1756-PB75,
1756-PB75K, 1756-PC75, 1756-PH75

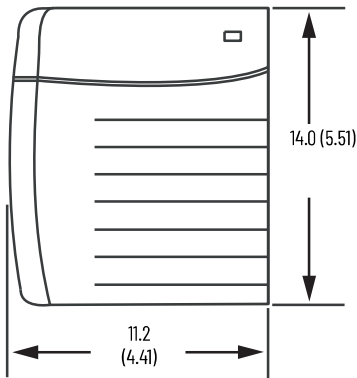

1756-PB50, 1756-PB50K

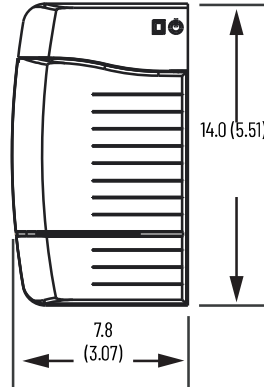

Dimensions are in cm (in.).

Technical Specifications - Standard DC Power Supplies

Attribute	1756-PB50, 1756-PB50K	1756-PB72/C, 1756-PB72K/C	1756-PB75/B, 1756-PB75K/B	1756-PC75/B	1756-PH75/B
Input voltage range	18...32V DC ⁽²⁾			30...60V DC ⁽⁵⁾	90...143V DC ⁽⁶⁾
Input voltage, nom	24V DC			48V DC	125V DC
Input power, max	85 W @ 50 °C (122 °F) 70 W @ 60 °C (140 °F)		95 W		
Output power, max	60 W @ 0...50 °C (32...122 °F) 50 W @ 0...60 °C (32...140 °F)		75 W @ 0...60 °C (32...140 °F) ⁽⁴⁾		
Inrush current, max	30 A				
Hold up time ⁽¹⁾	30 ms @ 18...32V DC, 60 W 40 ms @ 18...32V DC, 50 W		35 ms @ 18V DC 40 ms @ 24V DC 40 ms @ 32V DC		50 ms @ 30...60V DC nom
Current capacity @ 1.2V	1.5 A				
Current capacity @ 3.3V	2 A		4 A		
Current capacity @ 5.1V	8 A @ 50 °C (122 °F) 6 A @ 60 °C (140 °F)		10 A	13 A	
Current capacity @ 24V	2.5 A @ 50 °C (122 °F) 2.0 A @ 60 °C (140 °F)		2.8 A		
Isolation voltage	250V (continuous), Reinforced Insulation Type, Power Input to Backplane Type tested @ 3150V DC for 60 s		250V (continuous), Reinforced Insulation Type, Power Input to Backplane Type tested @ 3500V DC for 60 s		
Weight, approx	0.77 kg (1.7 lb)		0.95 kg (2.10 lb)		
Dimensions (HxWxD), approx	14.0 x 7.8 x 14.5 cm (5.51 x 3.07 x 5.71 in.)		14.0 x 11.2 x 14.5 cm (5.51 x 4.41 x 5.71 in.)		
Module location	Left side of 1756 chassis				
Chassis	1756-A4, 1756-A7, 1756-A10, 1756-A13, 1756-A17				
Chassis compatibility	Series A Series B Series C		Series B Series C		
Wire size	2.5 mm ² (14 AWG) solid or stranded copper wire that is rated at 90 °C (194 °F), or greater, 1.2 mm (3/64 in.) insulation max				
Wire category	1 - on power ports ⁽³⁾				
Conductor screw torque	0.565 N•m (5 lb•in)				
North American temperature code	T4				

Technical Specifications - Standard DC Power Supplies (Continued)

Attribute	1756-PB50, 1756-PB50K	1756-PB72/C, 1756-PB72K/C	1756-PB75/B, 1756-PB75K/B	1756-PC75/B	1756-PH75/B
ATEX temperature code	T4			-	
IEC temperature code	T4			-	
Enclosure type rating	None (open-style)				

- (1) The hold up time is the time between input voltage removal and DC power failure.
- (2) UL certification for 24V DC nominal. Rockwell Automation specified 18...32V DC.
- (3) Use this conductor category information to plan conductor routing as described in the system level installation manual. See the Industrial Automation Wiring and Grounding Guidelines, publication [1770-4.1](#).
- (4) The combination of all output power (5.1V backplane, 24V backplane, 3.3V backplane, and 1.2V backplane) can't exceed 75 W.
- (5) UL Certification for 48V DC nominal. Rockwell Automation specified 30...60V DC.
- (6) UL certification for 125V DC nominal. Rockwell Automation specified 90...143V DC.

Environmental Specifications - Standard DC Power Supplies

Attribute	1756-PB50, 1756-PB50K	1756-PB72/C, 1756-PB72K/C 1756-PB75/B, 1756-PB75K/B	1756-PC75/B, 1756-PH75/B
Temperature, operating IEC 60068-2-1 (Test Ae, Operating Cold), IEC 60068-2-2 (Test Be, Operating Dry Heat), IEC 60068-2-14 (Test Nb, Operating Thermal Shock)	0 °C < Ta < +60 °C (+32 °F < Ta < +140 °F)		
Temperature, surrounding air, max	60 °C (140 °F)		
Temperature, nonoperating IEC 60068-2-1 (Test Ab, Unpackaged Nonoperating Cold), IEC 60068-2-2 (Test Bb, Unpackaged Nonoperating Dry Heat), IEC 60068-2-14 (Test Na, Unpackaged Nonoperating Thermal Shock)	-40...+85 °C (-40...+185 °F)		
Relative humidity IEC 60068-2-30 (Test Db, Unpackaged Damp Heat)	5...95% noncondensing		
Vibration IEC 60068-2-6 (Test Fc, Operating)	2 g @ 10...500 Hz		
Shock, operating IEC 60068-2-27 (Test Ea, Unpackaged Shock)	30 g		
Shock, nonoperating IEC 60068-2-27 (Test Ea, Unpackaged Shock)	50 g ⁽¹⁾		
Emissions	IEC 61000-6-4		
ESD immunity IEC 61000-4-2	6 kV contact discharges 8 kV air discharges		
Radiated RF immunity IEC 61000-4-3	10V/m with 1 kHz sine wave 80% AM from 80...2000 MHz 10V/m with 200 Hz 50% Pulse 100% AM @ 900 MHz 10V/m with 200 Hz 50% Pulse 100% AM @ 1890 MHz 3V/m with 1 kHz sine wave 80% AM from 2000...2700 MHz		
EFT/B immunity IEC 61000-4-4	±4 kV at 5 kHz on power ports		
Surge transient immunity IEC 61000-4-5	±1 kV line-line (DM) and ±2 kV line-earth (CM) on power ports		
Conducted RF immunity IEC 61000-4-6	10V rms with 1 kHz sine wave 80% AM from 150 kHz...80 MHz		
Voltage variation IEC 61000-4-29	10 ms interruption on DC supply ports ⁽²⁾ 60% dips for 100 ms on DC supply ports 100% dips for 50 ms on DC supply ports ±20% fluctuations for 15 min on DC supply ports 5 s interruptions on DC supply ports ⁽³⁾		

- (1) Series C chassis have a maximum nonoperating shock value of 30 g. If you select a Series C chassis for use with your power supply, you're limited to a maximum nonoperating shock value of 30 g.
- (2) Short interruption test verifies ride-through. The supply remains fully functional under this condition.
- (3) Long interruption test verifies that repetitive inrush surge currents do not create any unsafe conditions. The supply fully shuts down and starts up in this test.

Certifications - Standard DC Power Supplies

Certification ⁽¹⁾	1756-PB50, 1756-PB50K	1756-PB72/C, 1756-PB72K/C 1756-PB75/B, 1756-PB75K/B	1756-PC75/B, 1756-PH75/B
UL	-		UL Listed Industrial Control Equipment. See UL File E65584.
c-UL-us	UL Listed Industrial Control Equipment, which is certified for US and Canada. See UL File E65584. UL Listed for Class I, Division 2 Group A,B,C,D Hazardous Locations, which are certified for US and Canada. See UL File E194810.		-
UKCA	In conformity with the following UK Statutory Instruments and their amendments: <ul style="list-style-type: none"> • 2016 No. 1091, Electromagnetic Compatibility Regulations • 2016 No. 1101, Electrical Equipment (Safety) Regulations • 2016 No. 1107, Equipment and Protective Systems Intended for Use in Potentially Explosive Atmospheres Regulations • 2012 No. 3032, Restriction of the Use of Certain Hazardous Substances in Electrical and Electronic Equipment 		
CSA	-	CSA Certified Process Control Equipment. See CSA File LR54689C. CSA Certified Process Control Equipment for Class I, Division 2 Group A,B,C,D Hazardous Locations. See CSA File LR69960C.	
FM	FM Approved Equipment for use in Class I Division 2 Group A,B,C,D Hazardous Locations		-
CE	European Union 2014/30/EU EMC Directive, compliant with: <ul style="list-style-type: none"> • EN 61326-1; Meas./Control/Lab., Industrial Requirements • EN 61000-6-2; Industrial Immunity • EN 61131-2; Programmable Controllers (Clause 8, Zone A & B) • EN 61000-6-4; Industrial Emissions European Union 2014/35/EU LVD, compliant with: <ul style="list-style-type: none"> • EN 61010-2-201; Control Equipment Safety Requirements 	European Union 2014/30/EU EMC Directive, compliant with: <ul style="list-style-type: none"> • EN 61326-1; Meas./Control/Lab., Industrial Requirements • EN 61000-6-2; Industrial Immunity • EN 61000-6-4; Industrial Emissions • EN 61131-2; Programmable Controllers (Clause 8, Zone A & B) European Union 2014/35/EU LVD, compliant with: <ul style="list-style-type: none"> • EN 61131-2; Programmable Controllers (Clause 11) 	
RCM	Australian Radiocommunications Act, compliant with: <ul style="list-style-type: none"> • EN 61000-6-4; Industrial Emissions 		
Ex	European Union 2014/34/EU ATEX Directive, compliant with: <ul style="list-style-type: none"> • IEC 60079-0 Edition 7; General Requirements • EN IEC 60079-7; Potentially Explosive Atmospheres, Protection "e" • II 3 G Ex ec IIC T4 X Gc • UL 22 ATEX 2819X 		-
IECEx	IECEx System, compliant with: <ul style="list-style-type: none"> • IEC 60079-0 Edition 7; General Requirements • IEC 60079-7; Potentially Explosive Atmospheres, Protection "e" • II 3 G Ex ec IIC T4 Gc • IECEx UL 22.0064X 		-
UKex	In conformity with the following UKex Statutory Instruments and their amendments: <ul style="list-style-type: none"> • Schedule 1 of the UKEX Regulation 2016 No. 1107 • Equipment protection by increased safety "e", reference certificate number UL22UKEX2605X • Zone 2 classification according to UKEX Regulation 2016 No. 1107 		-
KC	Korean Registration of Broadcasting and Communications Equipment, compliant with: <ul style="list-style-type: none"> • Article 58-2 of Radio Waves Act, Clause 3 		
EAC	Russian Customs Union TR CU 020/2011 EMC Technical Regulation Russian Customs Union TR CU 004/2011 LV Technical Regulation		
CCC	CCC 202012230911830, 202012230911998, 2020122309113868 CNCA-C23-01 强制性产品认证实施规则 防爆电气 CNCA-C23-01 CCC Implementation Rule Explosion-Proof Electrical Products		

(1) See the Product Certification link at rok.auto/certifications for Declarations of Conformity, Certificates, and other certification details.

1756 ControlLogix-XT Power Supplies

The ControlLogix-XT™ products include control and communication system components that, when used with FLEX I/O-XT™ products, provide a complete control system solution that you can use in environments where temperatures range from -20...+70 °C (-4...+158 °F).

When used independently, the ControlLogix-XT system can withstand environments where the temperature ranges from -25...+70 °C (-13...+158 °F).

Mounting Dimensions

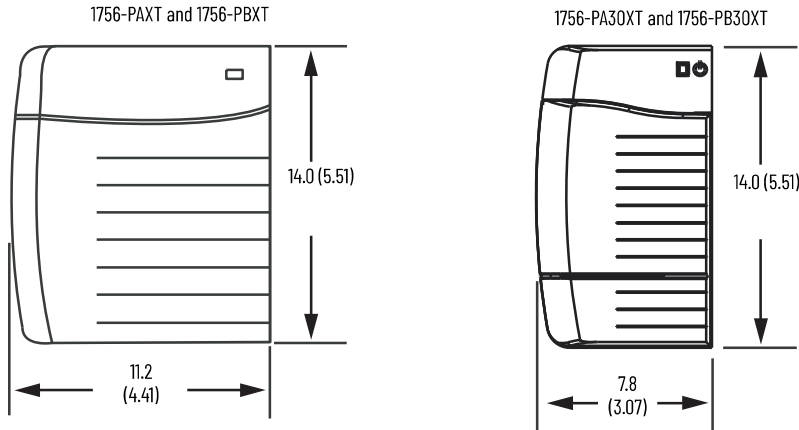

Dimensions are in cm (in.).

Technical Specifications - ControlLogix-XT Power Supplies

Attribute	1756-PAXT	1756-PA30XT	1756-PBXT	1756-PB30XT
Input voltage range	85...265V AC ⁽¹⁾		18...32V DC ⁽³⁾	
Input voltage, nom	120/240V AC		24V DC	
Input frequency range	47...63 Hz		-	
Input power, max	82VA 64 W	60VA 50 W	70 W	50 W
Output power, max	42 W @ -25...+70 °C (-13...+158 °F)	30 W @ -25...+70 °C (-13...+158 °F)	52 W @ -25...+70 °C (-13...+158 °F)	30 W @ -25...+70 °C (-13...+158 °F)
Inrush current, max	20 A		30 A	
Current capacity @ 1.2V	1.5 A			
Current capacity @ 3.3V	4 A	2 A	4 A	2 A
Current capacity @ 5.1V	8 A	6 A	10 A	6 A
Current capacity @ 24V	1.75 A	1.25 A	2.1 A	1.25 A
Isolation voltage	250V (continuous), Reinforced Insulation Type, Power Input to Backplane Type tested @ 3260V DC for 60 s	250V (continuous), Reinforced Insulation Type, Power Input to Backplane Type tested @ 3150V DC for 60 s	250V (continuous), Reinforced Insulation Type, Power Input to Backplane Type tested @ 3260V DC for 60 s	250V (continuous), Reinforced Insulation Type, Power Input to Backplane Type tested @ 3150V DC for 60 s
Weight, approx	0.95 kg (2.10 lb)	0.77 kg (1.7 lb)	0.95 kg (2.10 lb)	0.77 kg (1.7 lb)
Dimensions (HxWxD), approx	14.0 x 11.2 x 14.5 cm (5.51 x 4.41 x 5.71 in.)	14.0 x 7.8 x 14.5 cm (5.51 x 3.07 x 5.71 in.)	14.0 x 11.2 x 14.5 cm (5.51 x 4.41 x 5.71 in.)	14.0 x 7.8 x 14.5 cm (5.51 x 3.07 x 5.71 in.)
Module location	Left side of 1756 chassis			
Chassis	1756-A4LXT/B, 1756-A5XT/B, 1756-A7LXT/B, 1756-A7XT/B, 1756-A7XT/C, 1756-A10XT/C			
Wire size	2.5 mm ² (14 AWG) solid or stranded copper wire that is rated at 90 °C (194 °F), or greater, 1.2 mm (3/64 in.) insulation, max			
Wire category	1 - on power ports ⁽²⁾			
Conductor screw torque	0.565 N•m (5 lb•in)			
North American temperature code	T4		T4	

Technical Specifications - ControlLogix-XT Power Supplies (Continued)

Attribute	1756-PAXT	1756-PA30XT	1756-PBXT	1756-PB30XT
ATEX temperature code	-		T4	
IEC temperature code	-		T4	
Enclosure type rating	None (open-style)			

- (1) UL certification for 120/240V AC, 50/60 Hz nominal. Rockwell Automation specified 85...265V AC, 47...63 Hz.
 (2) Use this conductor category information to plan conductor routing as described in the system level installation manual. See the Industrial Automation Wiring and Grounding Guidelines, publication [1770-4.1](#).
 (3) UL certification for 24V DC nominal. Rockwell Automation specified 18...32V DC.

Environmental Specifications - ControlLogix-XT Power Supplies

Attribute	1756-PAXT	1756-PA30XT	1756-PBXT	1756-PB30XT
Temperature, operating IEC 60068-2-1 (Test Ae, Operating Cold), IEC 60068-2-2 (Test Be, Operating Dry Heat), IEC 60068-2-14 (Test Nb, Operating Thermal Shock)	-25 °C < Ta < +70 °C (-13 °F < Ta < +158 °F)			
Temperature, surrounding air, max	70 °C (158 °F)			
Temperature, nonoperating IEC 60068-2-1 (Test Ab, Unpackaged Nonoperating Cold), IEC 60068-2-2 (Test Bb, Unpackaged Nonoperating Dry Heat), IEC 60068-2-14 (Test Na, Unpackaged Nonoperating Thermal Shock)	-40...+85 °C (-40...+185 °F)			
Relative humidity IEC 60068-2-30 (Test Db, Unpackaged Damp Heat)	5...95% noncondensing			
Vibration IEC 60068-2-6 (Test Fc, Operating)	2 g @ 10...500 Hz			
Shock, operating IEC 60068-2-27 (Test Ea, Unpackaged Shock)	30 g			
Shock, nonoperating IEC 60068-2-27 (Test Ea, Unpackaged Shock)	50 g ⁽¹⁾			
Emissions	IEC 61000-6-4			
ESD immunity IEC 61000-4-2	6 kV contact discharges 8 kV air discharges			
Radiated RF immunity IEC 61000-4-3	10V/m with 1 kHz sine wave 80% AM from 80...2000 MHz 10V/m with 200 Hz 50% Pulse 100% AM at 900 MHz 10V/m with 200 Hz 50% Pulse 100% AM at 1890 MHz 3V/m with 1 kHz sine wave 80% AM from 2000...2700 MHz			
EFT/B immunity IEC 61000-4-4	±4 kV at 5 kHz on power ports			
Surge transient immunity IEC 61000-4-5	±1 kV line-line (DM) and ±2 kV line-earth (CM) on power ports			
Conducted RF immunity IEC 61000-4-6	10V rms with 1 kHz sine wave 80% AM from 150 kHz...80 MHz			
Voltage variation IEC 61000-4-11	30% dips for 1 period at 0° and 180° on AC supply ports 60% dips for 5 and 50 periods on AC supply ports ±10% fluctuations for 15 min on AC supply ports >95% interruptions for 250 periods on AC supply ports		-	
Voltage variation IEC 61000-4-29	-		10 ms interruption on DC supply ports ⁽²⁾ 60% dips for 100 ms on DC supply ports 100% dips for 50 ms on DC supply ports ±20% fluctuations for 15 min on DC supply ports 5 s interruptions on DC supply ports ⁽³⁾	
Damped oscillatory wave immunity IEC 61000-4-18	-	±2.5 kV line-line (DM) and ±2.5 kV line-earth (CM) on power ports	-	±2.5 kV line-line (DM) and ±2.5 kV line-earth (CM) on power ports

- (1) If you select a Series C chassis for use with your power supply, you're limited to a maximum nonoperating shock value of 30 g.
 (2) Short interruption test verifies ride-through. The supply remains fully functional under this condition.
 (3) Long interruption test verifies that repetitive inrush surge currents do not create any unsafe conditions. The supply fully shuts down and starts up in this test.

Certifications - ControlLogix-XT Power Supplies

Certification ⁽¹⁾	1756-PAXT	1756-PA30XT	1756-PBXT	1756-PB30XT
c-UL-us	UL Listed Industrial Control Equipment, which is certified for US and Canada. See UL File E65584. UL Listed for Class 1, Division 2 Group A,B,C,D Hazardous Locations, which are certified for US and Canada. See UL File E194810.			
CE	European Union 2014/30/EU EMC Directive, compliant with: <ul style="list-style-type: none"> EN 61326-1; Meas./Control/Lab., Industrial Requirements EN 61000-6-2; Industrial Immunity EN 61000-6-4; Industrial Emissions EN 61131-2; Programmable Controllers (Clause 8, Zone A & B) European Union 2014/35/EU LVD, compliant with: <ul style="list-style-type: none"> EN 61131-2; Programmable Controllers (Clause 11) 	European Union 2014/30/EU EMC Directive, compliant with: <ul style="list-style-type: none"> EN 61326-1; Meas./Control/Lab., Industrial Requirements EN 61000-6-2; Industrial Immunity EN 61000-6-4; Industrial Emissions EN 61131-2; Programmable Controllers (Clause 8, Zone A & B) European Union 2014/35/EU LVD, compliant with: <ul style="list-style-type: none"> EN 61010-2-201; Control Equipment Safety Requirements 	European Union 2014/30/EU EMC Directive, compliant with: <ul style="list-style-type: none"> EN 61326-1; Meas./Control/Lab., Industrial Requirements EN 61000-6-2; Industrial Immunity EN 61000-6-4; Industrial Emissions EN 61131-2; Programmable Controllers (Clause 8, Zone A & B) European Union 2014/35/EU LVD, compliant with: <ul style="list-style-type: none"> EN 61131-2; Programmable Controllers (Clause 11) 	European Union 2014/30/EU EMC Directive, compliant with: <ul style="list-style-type: none"> EN 61326-1; Meas./Control/Lab., Industrial Requirements EN 61000-6-2; Industrial Immunity EN 61000-6-4; Industrial Emissions EN 61131-2; Programmable Controllers (Clause 8, Zone A & B) European Union 2014/35/EU LVD, compliant with: <ul style="list-style-type: none"> EN 61010-2-201; Control Equipment Safety Requirements
UKCA	In conformity with the following UK Statutory Instruments and their amendments: <ul style="list-style-type: none"> 2016 No. 1091, Electromagnetic Compatibility Regulations 2016 No. 1101, Electrical Equipment (Safety) Regulations 2016 No. 1107, Equipment and Protective Systems Intended for Use in Potentially Explosive Atmospheres Regulations 2012 No. 3032, Restriction of the Use of Certain Hazardous Substances in Electrical and Electronic Equipment 			
RCM	Australian Radiocommunications Act, compliant with: <ul style="list-style-type: none"> EN 61000-6-4; Industrial Emissions 			
Ex	-	European Union 2014/34/EU ATEX Directive, compliant with: <ul style="list-style-type: none"> EN IEC 60079-0; General Requirements EN IEC 60079-7; Potentially Explosive Atmospheres, Protection "e" II 3 G Ex ec IIC T4 Gc UL 22 ATEX 2819X 		
UKEX	-	In conformity with the following UKEX Statutory Instruments and their amendments: <ul style="list-style-type: none"> Schedule 1 of the UKEX Regulation 2016 No. 1107 Equipment protection by increased safety "e", reference certificate number UL22UKEX2605X Zone 2 classification according to UKEX Regulation 2016 No. 1107 		
IECEx	-	IECEx System, compliant with: <ul style="list-style-type: none"> IEC 60079-0; General Requirements IEC 60079-7; Potentially Explosive Atmospheres, Protection "e" II 3 G Ex ec IIC T4 Gc IECEx UL 22.0064X 		
KC	Korean Registration of Broadcasting and Communications Equipment, compliant with: <ul style="list-style-type: none"> Article 58-2 of Radio Waves Act, Clause 3 			
EAC	Russian Customs Union TR CU 020/2011 EMC Technical Regulation Russian Customs Union TR CU 004/2011 LV Technical Regulation			
CCC	CCC 202012230911830, 202012230911998, 2020122309113868 CNCA-C23-01 强制性产品认证实施规则 防爆电气 CNCA-C23-01 CCC Implementation Rule Explosion-Proof Electrical Products			

(1) See the Product Certification link at rok.auto/certifications for Declarations of Conformity, Certificates, and other certification details.

Redundant Power Supplies

To build a redundant power supply system, you need the following.

Cat. No.	Description	Amount
1756-PA75R/A, 1756-PA75RK/A, 1756-PAXTR, 1756-PB75R/A, 1756-PB75RK/A, or 1756-PBXTR	Redundant power supply	2
1756-CPR2 ⁽¹⁾ 1756-CPR2D ⁽²⁾ or 1756-CPR2U ⁽²⁾	Redundant power supply cable (Length = 0.91 m [3 ft])	2
1756-PSCA2, 1756-PSCA2K, or 1756-PSCA2XT	Redundant power supply chassis adapter ⁽³⁾	1
User-supplied	Annunciator wiring ⁽⁴⁾ (Length, max = 10 m [32.8 ft])	2

- (1) Cable bend radius is 12.7 cm (5.0 in.).
- (2) Requires 10.16 cm (4.0 in.) of clearance next to the chassis adapter.
- (3) The 1756-PSCA2 or 1756-PSCA-2XT chassis adapter is a passive device. The adapter funnels power from the redundant power supplies to the single power connector on the ControlLogix® series B chassis backplane.
- (4) Optional user-provided annunciator wiring can be connected to the solid-state relay for status and troubleshooting.

System Configuration Recommendations

We recommend that you use one of these methods to configure your redundant power supply system.

Recommended Configurations for a System That Uses One Chassis

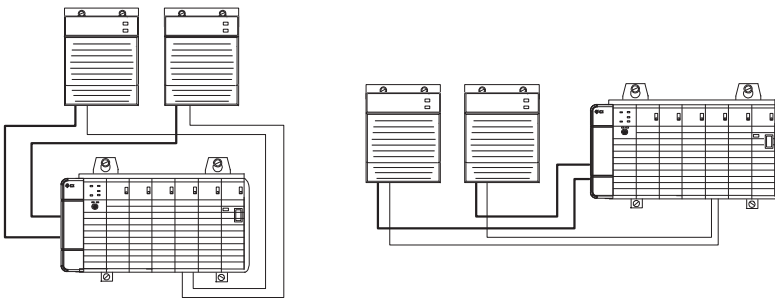

Recommended Configurations for a System That Uses Two Chassis

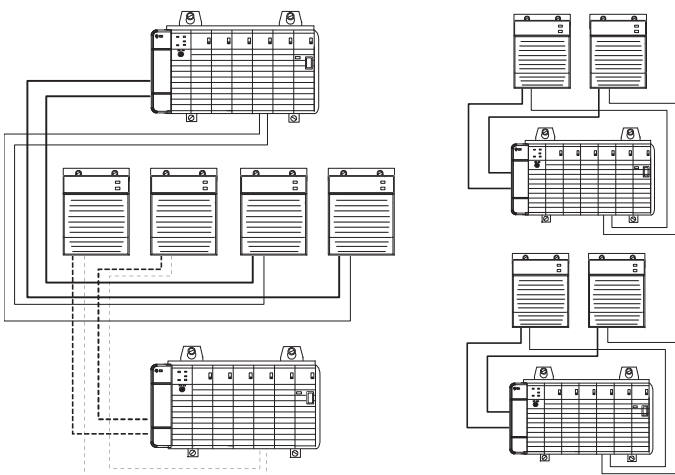

Mounting Dimensions

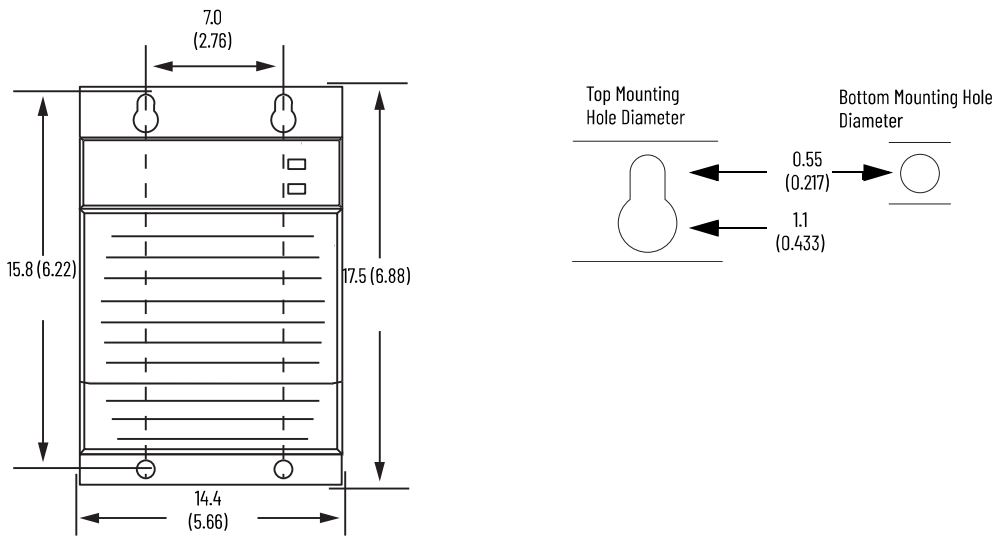

Dimensions are in cm (in.).

Redundant Power Supply Features

The redundant power supplies offer the same features as the standard power supplies, and the following:

- Redundant operation
- Automatic chassis load sharing between the redundant power supplies
- Status indicators for visual operating status of the pair
- Solid-state relay for system recognition of supply status when wired to an input module
- The ControlLogix redundant power supply system is designed to account for operational anomalies in only the power supply (the chassis adapter and power supply cables are excluded)

Technical Specifications - ControlLogix Redundant Power Supplies

Attribute	1756-PA75R, 1756-PA75RK	1756-PB75R, 1756-PB75RK
Input voltage range	85...265V AC ⁽¹⁾	18...32V DC ⁽²⁾
Input voltage	120V/240V AC, 50/60 Hz	24V DC
Input frequency range	47...63 Hz	-
Input power, max	120VA 115 W	110 W
Output power, max	75 W @ 0...60 °C (32...140 °F)	
Inrush current, max	20 A	30 A
Hold up time ⁽³⁾	2 cycles @ 60 Hz 2 cycles @ 50 Hz	20 ms
Current capacity @ 1.2V	1.5 A	
Current capacity @ 3.3V	4 A	
Current capacity @ 5.1V	13 A	
Current capacity @ 24V	2.8 A	
Annunciator power	240V AC 50/60 Hz, 240V DC, 50 mA, resistive only	90V DC for ATEX/IECEX
Isolation voltage	250V (continuous), Reinforced Insulation Type, Power Input to Backplane, Power Input to Annunciator, Annunciator to Backplane Type tested at 3250V DC for 60 s	
Dimensions (HxWxD), approx	17.5 x 14.5 x 13.7 cm (6.9 x 5.7 x 5.4 in.)	
Weight, approx	1.45 kg (3.2 lb)	

Technical Specifications - ControlLogix Redundant Power Supplies (Continued)

Attribute	1756-PA75R, 1756-PA75RK	1756-PB75R, 1756-PB75RK
Chassis	1756-A4, 1756-A7, 1756-A10, 1756-A13, 1756-A17	
Wire size	Power: 2.5 mm ² (14 AWG) solid or stranded copper wire that is rated at 90 °C (194 °F), or greater, 1.2 mm (3/64 in.) insulation max Annunciator: 0.25...2.5 mm ² (22...14 AWG) solid or stranded copper wire that is rated at 90 °C (194 °F), or greater, 1.2 mm (3/64 in.) insulation max	
Wire category ⁽⁴⁾	3 - on annunciator ports 1 - on power ports 3 - on 1756-CPR2 connections	
Pilot duty rating	Annunciator - not rated	
Conductor screw torque	0.565 N•m (5 lb•in)	
North American temperature code	T3C	T4
ATEX temperature code	-	T4
IEC temperature code	-	T4
Enclosure type rating	None (open-style)	

(1) UL certification for 120/240V AC, 50/60 Hz nominal. Rockwell Automation specified 85...265V AC, 47...63 Hz.

(2) UL certification for 24V DC nominal. Rockwell Automation specified 18...32V DC.

(3) The hold up time is the time between input voltage removal and DC power failure.

(4) Use this conductor category information to plan conductor routing. See the Industrial Automation Wiring and Grounding Guidelines, publication [1770-4.1](#).

Environmental Specifications - ControlLogix Redundant Power Supplies

Attribute	1756-PA75R, 1756-PA75RK	1756-PB75R, 1756-PB75RK
Temperature, operating IEC 60068-2-1 (Test Ae, Operating Cold), IEC 60068-2-2 (Test Be, Operating Dry Heat), IEC 60068-2-14 (Test Nb, Operating Thermal Shock)	0...60 °C (32...140 °F)	
Temperature, surrounding air, max	60 °C (140 °F)	
Temperature, nonoperating IEC 60068-2-1 (Test Ab, Unpackaged Nonoperating Cold), IEC 60068-2-2 (Test Bb, Unpackaged Nonoperating Dry Heat), IEC 60068-2-14 (Test Na, Unpackaged Nonoperating Thermal Shock)	-40...+85 °C (-40...+185 °F)	
Relative humidity IEC 60068-2-30 (Test Db, Unpackaged Damp Heat)	5...95% noncondensing	
Vibration IEC 60068-2-6 (Test Fc, Operating)	2 g @ 10...500 Hz	
Shock, operating IEC 60068-2-27 (Test Ea, Unpackaged Shock)	30 g	
Shock, nonoperating IEC 60068-2-27 (Test Ea, Unpackaged Shock)	50 g	
Emissions	IEC 61000-6-4	
ESD immunity IEC 61000-4-2	6 kV contact discharges 8 kV air discharges	
Radiated RF immunity IEC 61000-4-3	10V/m with 1 kHz sine wave 80% AM from 80...2000 MHz 10V/m with 200 Hz 50% Pulse 100% AM @ 900 MHz 10V/m with 200 Hz 50% Pulse 100% AM at 1890 MHz 3V/m with 1 kHz sine wave 80% AM from 2000...2700 MHz	
EFT/B immunity IEC 61000-4-4	±4 kV at 5 kHz on power ports ±4 kV at 5 kHz on annunciator ports	
Surge transient immunity IEC 61000-4-5	±1 kV line-line (DM) and ±2 kV line-earth (CM) on power ports	
Conducted RF immunity IEC 61000-4-6	15V rms with 1 kHz sine wave 80% AM from 150 kHz...80 MHz	

Environmental Specifications - ControlLogix Redundant Power Supplies (Continued)

Attribute	1756-PA75R, 1756-PA75RK	1756-PB75R, 1756-PB75RK
Conducted audio immunity IEC 945	2 W max from rated frequency to the 200th harmonic on AC supply ports	
Voltage variation IEC 61000-4-11	30% dips for 1 period at 0° and 180° on AC supply ports 60% dips for 5 and 50 periods on AC supply ports ±10% fluctuations for 15 min on AC supply ports >95% interruptions for 250 periods on AC supply ports	-
Voltage variation IEC 61000-4-29	-	10 ms interruption on DC supply ports ⁽¹⁾ 60% dips for 100 ms on DC supply ports 100% dips for 50 ms on DC supply ports ±20% fluctuations for 15 min on DC supply ports 5 s interruptions on DC supply ports ⁽²⁾

(1) Short interruption test verifies ride-through. The supply remains fully functional under this condition.

(2) Long interruption test verifies that repetitive inrush surge currents do not create any unsafe conditions. The supply fully shuts down and starts up in this test.

Certifications - ControlLogix Redundant Power Supplies

Certification ⁽¹⁾	1756-PA75R, 1756-PA75RK	1756-PB75R, 1756-PB75RK
c-UL-us	UL Listed Industrial Control Equipment, which is certified for US and Canada. See UL File E65584. UL Listed for Class I, Division 2 Group A,B,C,D Hazardous Locations, which are certified for U.S. and Canada. See UL File E194810.	
CSA	CSA Certified Process Control Equipment. See CSA File LR54689C. CSA Certified Process Control Equipment for Class I, Division 2 Group A,B,C,D Hazardous Locations. See CSA File LR69960C.	
UKCA	In conformity with the following UK Statutory Instruments and their amendments: <ul style="list-style-type: none"> • 2016 No. 1091, Electromagnetic Compatibility Regulations • 2016 No. 1101, Electrical Equipment (Safety) Regulations • 2016 No. 1107, Equipment and Protective Systems Intended for Use in Potentially Explosive Atmospheres Regulations • 2012 No. 3032, Restriction of the Use of Certain Hazardous Substances in Electrical and Electronic Equipment 	
FM	FM Approved Equipment for use in Class I Division 2 Group A,B,C,D Hazardous Locations	
CE	European Union 2014/30/EU EMC Directive, compliant with: <ul style="list-style-type: none"> • EN 61326-1; Meas./Control/Lab., Industrial Requirements • EN 61000-6-2; Industrial Immunity • EN 61000-6-4; Industrial Emissions • EN 61131-2; Programmable Controllers (Clause 8, Zone A & B) European Union 2014/35/EU LVD, compliant with: <ul style="list-style-type: none"> • EN 61131-2; Programmable Controllers (Clause 11) 	
RCM	Australian Radiocommunications Act, compliant with: <ul style="list-style-type: none"> • EN 61000-6-4; Industrial Emissions 	
Ex	-	European Union 2014/34/EU ATEX Directive, compliant with: <ul style="list-style-type: none"> • EN IEC 60079-0; General Requirements • EN IEC 60079-7; Potentially Explosive Atmospheres, Protection "e" • II 3 G Ex ec IIC T4 Gc • UL 22 ATEX 2819X
IECEx	-	IECEx System, compliant with: <ul style="list-style-type: none"> • IEC 60079-0; General Requirements • IEC 60079-7; Potentially Explosive Atmospheres, Protection "e" • II 3 G Ex ec IIC T4 Gc • IECEx UL 22.0064X
UKEX	-	In conformity with the following UKEX Statutory Instruments and their amendments: <ul style="list-style-type: none"> • Schedule 1 of the UKEX Regulation 2016 No. 1107 • Equipment protection by increased safety "e", reference certificate number UL22UKEX2605X • Zone 2 classification according to UKEX Regulation 2016 No. 1107
KC	Korean Registration of Broadcasting and Communications Equipment, compliant with: <ul style="list-style-type: none"> • Article 58-2 of Radio Waves Act, Clause 3 	
EAC	Russian Customs Union TR CU 020/2011 EMC Technical Regulation Russian Customs Union TR CU 004/2011 LV Technical Regulation	
CCC	CCC 202012230911830, 202012230911998, 2020122309113868 CNCA-C23-01 强制性产品认证实施规则 防爆电气 CNCA-C23-01 CCC Implementation Rule Explosion-Proof Electrical Products	

(1) See the Product Certification link at rok.auto/certifications for Declarations of Conformity, Certificates, and other certification details.

Technical Specifications - ControlLogix-XT Redundant Power Supplies

Attribute	1756-PAXTR	1756-PBXTR
Input voltage range	85...265V AC ⁽²⁾	18...32V DC
Input voltage	120V/240V AC	24V DC
Input frequency range	47...63 Hz	-
Input power, max	75VA 65 W	81 W
Output power, max	42 W @ 0...60 °C (32...140 °F)	52 W
Inrush current, max	20 A	30 A
Current capacity @ 1.2V	1.5 A	
Current capacity @ 3.3V	4 A	
Current capacity @ 5.1V	8 A	10 A
Current capacity @ 24V	1.75 A	2.1 A
Annunciator power	240V AC 50/60 Hz, 240V DC, 50 mA, resistive only	240V AC 50/60 Hz, 240V DC, 50 mA, resistive only 90V DC for ATEX/IECEX
Isolation voltage	250V (continuous), Reinforced Insulation Type, Power Input to Backplane, Power Input to Annunciator, Annunciator to Backplane Type tested at 3250V DC for 60 s	
Dimensions (HxWxD), approx	17.5 x 14.5 x 13.7 cm (6.9 x 5.7 x 5.4 in.)	
Weight, approx	1.45 kg (3.2 lb)	
Chassis	1756-A4/B, 1756-A7/B, 1756-A10/B, 1756-A13/B, 1756-A17/B, 1756-A4LXT/B, 1756-A5XT/B, 1756-A7LXT/B, 1756-A7XT/B 1756-A4/C, 1756-A7/C, 1756-A10/C, 1756-A13/C, 1756-A17/C, 1756-A7XT/C, 1756-A10XT/C	
Wire size	Power: 2.5 mm ² (14 AWG) solid or stranded copper wire that is rated at 90 °C (194 °F), or greater, 1.2 mm (3/64 in.) insulation max Annunciator: 0.25...2.5 mm ² (22...14 AWG) solid or stranded copper wire that is rated at 90 °C (194 °F), or greater, 1.2 mm (3/64 in.) insulation max	
Wire category ⁽¹⁾	1 - on power ports 3 - on annunciator ports 3 - on 1756-CPR2 connections	
Pilot duty rating	Annunciator - not rated	
Conductor screw torque	0.565 N•m (5 lb•in)	
North American temperature code	T4A	
ATEX temperature code	-	T4
IEC temperature code	-	T4
Enclosure type rating	None (open-style)	

(1) Use this conductor category information to plan conductor routing. See Industrial Automation Wiring and Grounding Guidelines, publication [1770-4.1](#).

(2) UL certification for 120/240V AC, 50/60 Hz nominal. Rockwell Automation specified 85...265V AC, 47...63 Hz.

Environmental Specifications - ControlLogix-XT Redundant Power Supplies

Attribute	1756-PAXTR	1756-PBXTR
Temperature, operating IEC 60068-2-1 (Test Ae, Operating Cold), IEC 60068-2-2 (Test Be, Operating Dry Heat), IEC 60068-2-14 (Test Nb, Operating Thermal Shock)	-25...+70 °C (13...158 °F)	
Temperature, surrounding air, max	70 °C (158 °F)	
Temperature, nonoperating IEC 60068-2-1 (Test Ab, Unpackaged Nonoperating Cold), IEC 60068-2-2 (Test Bb, Unpackaged Nonoperating Dry Heat), IEC 60068-2-14 (Test Na, Unpackaged Nonoperating Thermal Shock)	-40...+85 °C (-40...+185 °F)	
Relative humidity IEC 60068-2-30 (Test Db, Unpackaged Damp Heat)	5...95% noncondensing	
Vibration IEC 60068-2-6 (Test Fc, Operating)	2 g @ 10...500 Hz	
Shock, operating IEC 60068-2-27 (Test Ea, Unpackaged Shock)	30 g	
Shock, nonoperating IEC 60068-2-27 (Test Ea, Unpackaged Shock)	50 g	

Environmental Specifications - ControlLogix-XT Redundant Power Supplies (Continued)

Attribute	1756-PAXTR	1756-PBXTR
Emissions	IEC 61000-6-4	
ESD immunity IEC 61000-4-2	6 kV contact discharges 8 kV air discharges	
Radiated RF immunity IEC 61000-4-3	10V/m with 1 kHz sine wave 80% AM from 80...2000 MHz 10V/m with 200 Hz 50% Pulse 100% AM @ 900 MHz 10V/m with 200 Hz 50% Pulse 100% AM at 1890 MHz 3V/m with 1 kHz sine wave 80% AM from 2000...2700 MHz	
EFT/B immunity IEC 61000-4-4	±4 kV at 5 kHz on power ports ±4 kV at 5 kHz on annunciator ports	
Surge transient immunity IEC 61000-4-5	±1 kV line-line (DM) and ±2 kV line-earth (CM) on power ports	
Conducted RF immunity IEC 61000-4-6	15V rms with 1 kHz sine wave 80% AM from 150 kHz...80 MHz	10V rms with 1 kHz sine wave 80% AM from 150 kHz...80 MHz
Conducted audio immunity IEC 945	2 W max from rated frequency to the 200th harmonic on AC supply ports	
Voltage variation IEC 61000-4-11	30% dips for 1 period at 0° and 180° on AC supply ports 60% dips for 5 and 50 periods on AC supply ports ±10% fluctuations for 15 min on AC supply ports >95% interruptions for 250 periods on AC supply ports	-
Voltage variation IEC 61000-4-29	-	10 ms interruption on DC supply ports ⁽¹⁾ 60% dips for 100 ms on DC supply ports 100% dips for 50 ms on DC supply ports ±20% fluctuations for 15 min on DC supply ports 5 s interruptions on DC supply ports ⁽²⁾

(1) Short interruption test verifies ride-through. The supply remains fully functional under this condition.

(2) Long interruption test verifies that repetitive inrush surge currents do not create any unsafe conditions. The supply fully shuts down and starts up in this test.

Certifications - ControlLogix-XT Redundant Power Supplies

Certification ⁽¹⁾	1756-PAXTR	1756-PBXTR
c-UL-us	UL Listed Industrial Control Equipment, which is certified for US and Canada. See UL File E65584. UL Listed for Class I, Division 2 Group A,B,C,D Hazardous Locations, which are certified for U.S. and Canada. See UL File E194810.	
CE	European Union 2014/30/EU EMC Directive, compliant with: <ul style="list-style-type: none"> EN 61326-1; Meas./Control/Lab., Industrial Requirements EN 61000-6-2; Industrial Immunity EN 61000-6-4; Industrial Emissions EN 61131-2; Programmable Controllers (Clause 8, Zone A & B) European Union 2014/35/EU LVD, compliant with: <ul style="list-style-type: none"> EN 61131-2; Programmable Controllers (Clause 11) 	
RCM	Australian Radiocommunications Act, compliant with: <ul style="list-style-type: none"> EN 61000-6-4; Industrial Emissions 	
Ex	-	European Union 2014/34/EU ATEX Directive, compliant with: <ul style="list-style-type: none"> EN IEC 60079-0; General Requirements EN IEC 60079-7; Potentially Explosive Atmospheres, Protection "e" II 3 G Ex ec IIC T4 Gc UL 22 ATEX 2819X
IECEx	-	IECEx System, compliant with: <ul style="list-style-type: none"> IEC 60079-0; General Requirements IEC 60079-7; Potentially Explosive Atmospheres, Protection "e" II 3 G Ex ec IIC T4 Gc IECEx UL 22.0064X
UKEX	-	In conformity with the following UKex Statutory Instruments and their amendments: <ul style="list-style-type: none"> Schedule 1 of the UKEX Regulation 2016 No. 1107 Equipment protection by increased safety "e", reference certificate number UL22UKEX2605X Zone 2 classification according to UKEX Regulation 2016 No. 1107
UKCA	In conformity with the following UK Statutory Instruments and their amendments: <ul style="list-style-type: none"> 2016 No. 1091, Electromagnetic Compatibility Regulations 2016 No. 1101, Electrical Equipment (Safety) Regulations 2016 No. 1107, Equipment and Protective Systems Intended for Use in Potentially Explosive Atmospheres Regulations 2012 No. 3032, Restriction of the Use of Certain Hazardous Substances in Electrical and Electronic Equipment 	

Certifications - ControlLogix-XT Redundant Power Supplies (Continued)

Certification ⁽¹⁾	1756-PAXTR	1756-PBXTR
KC	Korean Registration of Broadcasting and Communications Equipment, compliant with: <ul style="list-style-type: none"> Article 58-2 of Radio Waves Act, Clause 3 	
EAC	Russian Customs Union TR CU 020/2011 EMC Technical Regulation Russian Customs Union TR CU 004/2011 LV Technical Regulation	
CCC	CCC 202012230911830, 202012230911998, 2020122309113868 CNCA-C23-01 强制性产品认证实施规则 防爆电气 CNCA-C23-01 CCC Implementation Rule Explosion-Proof Electrical Products	

(1) See the Product Certification link at rok.auto/certifications for Declarations of Conformity, Certificates, and other certification details.

Redundant Power Supply Chassis Adapters

Technical Specifications - Redundant Power Supply Chassis Adapters

Attribute	1756-PSCA2, 1756-PSCA2K	1756-PSCA2XT
Current capacity @ 1.2V DC	1.5 A	
Current capacity @ 3.3V DC	4 A	
Current capacity @ 5.1V DC	15 A	
Current capacity @ 24V DC	2.8 A	
Wire category ⁽¹⁾	3 - on 1756-CPR2 connections	
North American temperature code	T5	T4A
ATEX temperature code	T4	
IEC temperature code	T4	
Enclosure type rating	None (open-style)	

(1) Use this conductor category information to plan conductor routing. See the Industrial Automation Wiring and Grounding Guidelines, publication 1770-4.1.

Environmental Specifications - Redundant Power Supply Chassis Adapters

Attribute	1756-PSCA2, 1756-PSCA2K	1756-PSCA2XT
Temperature, operating IEC 60068-2-1 (Test Ae, Operating Cold), IEC 60068-2-2 (Test Be, Operating Dry Heat), IEC 60068-2-14 (Test Nb, Operating Thermal Shock)	0...60 °C (32...140 °F)	-25...+70 °C (-13...+158 °F)
Temperature, surrounding air, max	60 °C (140 °F)	70 °C (158 °F)
Temperature, nonoperating IEC 60068-2-1 (Test Ab, Unpackaged Nonoperating Cold), IEC 60068-2-2 (Test Bb, Unpackaged Nonoperating Dry Heat), IEC 60068-2-14 (Test Na, Unpackaged Nonoperating Thermal Shock)	-40...+85 °C (-40...+185 °F)	
Relative humidity IEC 60068-2-30 (Test Db, Unpackaged Damp Heat)	5...95% noncondensing	
Vibration IEC 60068-2-6 (Test Fc, Operating)	2 g @ 10...500 Hz	
Shock, operating IEC 60068-2-27 (Test Ea, Unpackaged Shock)	30 g	
Shock, nonoperating IEC 60068-2-27 (Test Ea, Unpackaged Shock)	50 g	
Emissions	IEC 61000-6-4	
ESD immunity IEC 61000-4-2	6 kV contact discharges 8 kV air discharges	
Radiated RF immunity IEC 61000-4-3	10V/m with 1 kHz sine wave 80% AM from 80...2000 MHz 10V/m with 200 Hz 50% Pulse 100% AM at 900 MHz 10V/m with 200 Hz 50% Pulse 100% AM at 1890 MHz 3V/m with 1 kHz sine wave 80% AM from 2000...2700 MHz	

Certifications - Redundant Power Supply Chassis Adapters

Certification ⁽¹⁾	1756-PSCA2, 1756-PSCA2K	1756-PSCA2XT
c-UL-us	UL Listed Industrial Control Equipment, which is certified for US and Canada. See UL File E65584. UL Listed for Class I, Division 2 Group A,B,C,D Hazardous Locations, which are certified for U.S. and Canada. See UL File E194810.	
CSA	CSA Certified Process Control Equipment. See CSA File LR54689C. CSA Certified Process Control Equipment for Class I, Division 2 Group A,B,C,D Hazardous Locations. See CSA File LR69960C.	-
UKEX	In conformity with the following UKex Statutory Instruments and their amendments: <ul style="list-style-type: none"> Schedule 1 of the UKEX Regulation 2016 No. 1107 Equipment protection by increased safety "e", reference certificate number UL22UKEX2605X Zone 2 classification according to UKEX Regulation 2016 No. 1107 	
UKCA	In conformity with the following UK Statutory Instruments and their amendments: <ul style="list-style-type: none"> 2016 No. 1091, Electromagnetic Compatibility Regulations 2016 No. 1101, Electrical Equipment (Safety) Regulations 2016 No. 1107, Equipment and Protective Systems Intended for Use in Potentially Explosive Atmospheres Regulations 2012 No. 3032, Restriction of the Use of Certain Hazardous Substances in Electrical and Electronic Equipment 	
FM	FM Approved Equipment for use in Class I Division 2 Group A,B,C,D Hazardous Locations	-
CE	European Union 2014/30/EU EMC Directive, compliant with: <ul style="list-style-type: none"> EN 61326-1; Meas./Control/Lab., Industrial Requirements EN 61000-6-2; Industrial Immunity EN 61000-6-4; Industrial Emissions EN 61131-2; Programmable Controllers (Clause 8, Zone A & B) 	
RCM	Australian Radiocommunications Act, compliant with: <ul style="list-style-type: none"> EN 61000-6-4; Industrial Emissions 	
Ex	European Union 2014/34/EU ATEX Directive, compliant with: <ul style="list-style-type: none"> EN IEC 60079-0; General Requirements EN IEC 60079-7; Potentially Explosive Atmospheres, Protection "e" II 3 G Ex ec IIC T4 Gc UL 22 ATEX 2819X 	
IECEX	IECEX System, compliant with: <ul style="list-style-type: none"> IEC 60079-0; General Requirements IEC 60079-7; Potentially Explosive Atmospheres, Protection "e" II 3 G Ex ec IIC T4 Gc IECEX UL 22.0064X 	
KC	Korean Registration of Broadcasting and Communications Equipment, compliant with: <ul style="list-style-type: none"> Article 58-2 of Radio Waves Act, Clause 3 	
EAC	Russian Customs Union TR CU 020/2011 EMC Technical Regulation Russian Customs Union TR CU 004/2011 LV Technical Regulation	
CCC	CCC 202012230911830, 202012230911998, 2020122309113868 CNCA-C23-01 强制性产品认证实施规则 防爆电气 CNCA-C23-01 CCC Implementation Rule Explosion-Proof Electrical Products	

(1) See the Product Certification link at rok.auto/certifications for Declarations of Conformity, Certificates, and other certification details.

Power Load and Transformer Sizing

The following graphs show the input power requirements for slim and standard power supplies, given the power that they're providing to the modules in the chassis.

Follow these steps to determine the power requirements for your chassis.

1. Calculate the Backplane Power load by adding the power draw (in watts) for all planned modules.
For module power draws, refer to the module specification tables in the ControlLogix Selection Guide, publication [1756-SG001](#).
2. Locate the Backplane Power load on the vertical (y) axis of the graph and determine the corresponding Real Power (input-power) rating on the horizontal (x) axis.
The Real Power value is the amount of power that is consumed by the power supply.

Slim Power Supply Power Requirements

1756-PA50, 1756-PA50K @ 50 °C (AC)

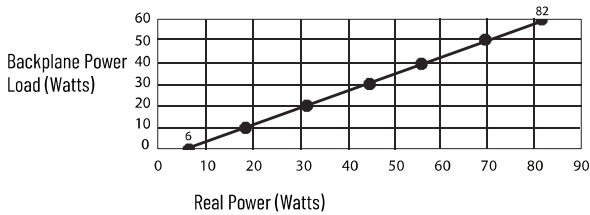

1756-PB50, 1756-PB50K @ 60 °C (DC)

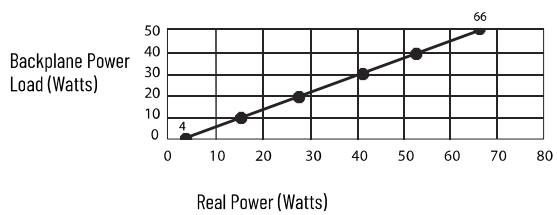

1756-PA50, 1756-PA50K @ 60 °C (AC)

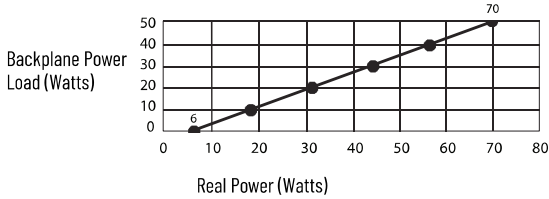

1756-PA30XT (AC)

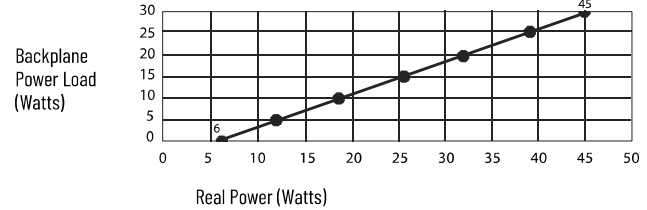

1756-PB50, 1756-PB50K @ 50 °C (DC)

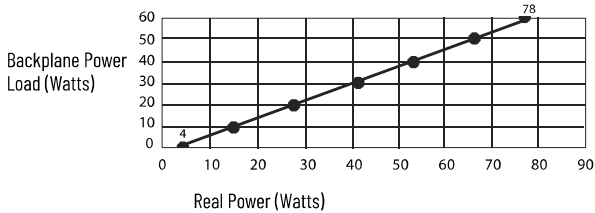

1756-PB30XT (DC)

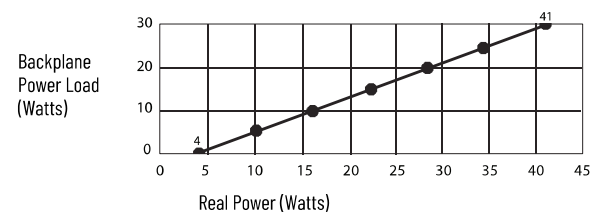

Apparent Power (Watts) = Transformer Load (VA) = Real Power (Watts)

Standard Power Supply Power Requirements

1756-PA72/C, 1756-PA72K/C, 1756-PA75/B (AC), 1756-PA75K/B (AC)

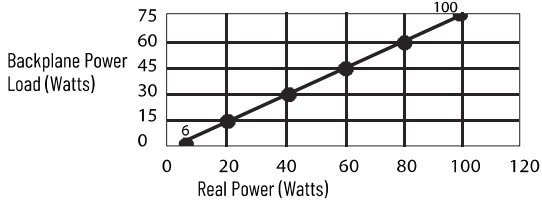

1756-PBXT (DC)

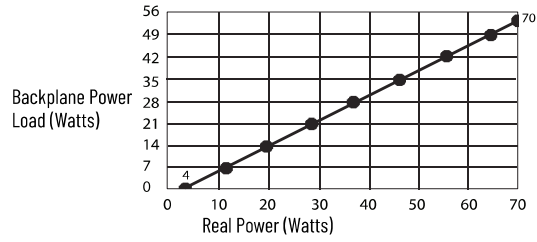

1756-PB72/C, 1756-PB72K/C, 1756-PB75/B (AC), 1756-PB75K/B (DC)

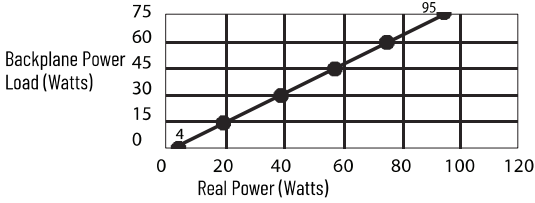

1756-PBXT (DC)

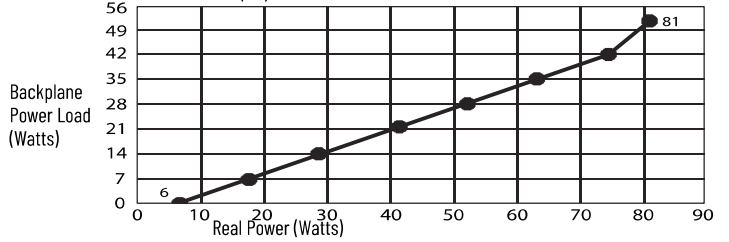

1756-PH75/B, 1756-PC75/B (DC)

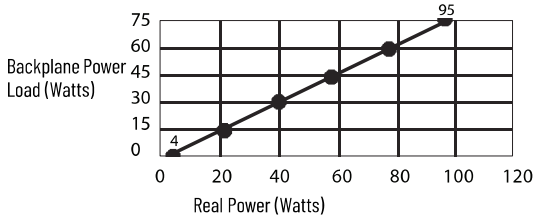

1756-PA75R/A, 1756-PA75RK/A(AC)

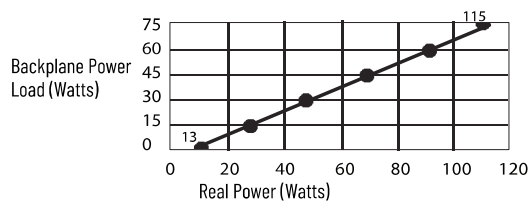

1756-PAXT (AC)

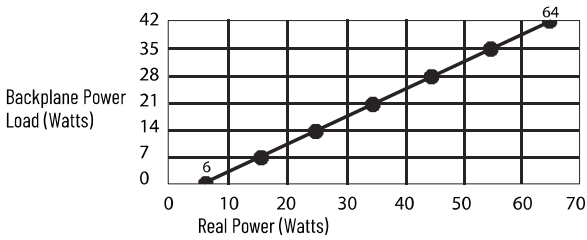

1756-PB75R/A, 1756-PB75RK/A (DC)

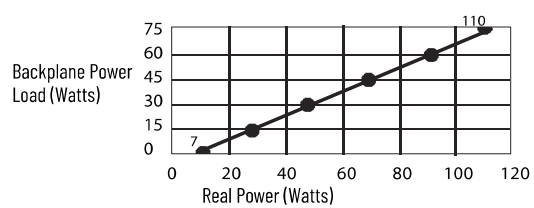

1756-PAXTR (AC)

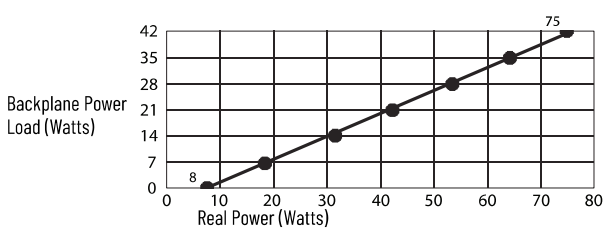

Apparent Power (Watts) = Transformer Load (VA) = Real Power (Watts)

Notes:

Additional Resources

These documents contain additional information concerning related products from Rockwell Automation.

Resource	Description
ControlLogix Chassis Specifications Technical Data, publication 1756-TD006	Provides technical specifications for ControlLogix chassis.
ControlLogix Selection Guide, publication 1756-SG001	Provides overview of the ControlLogix system and its products.
ControlLogix Power Supply Installation Instructions, publication 1756-IN619	Provides information on how to install ControlLogix standard power supplies.
ControlLogix Redundant Power Supply Installation Instructions, publication 1756-IN620	Provides information on how to install ControlLogix redundant power supplies.
ControlLogix Chassis Installation Instructions, publication 1756-IN621	Provides information on how to install ControlLogix chassis.
ControlLogix System User Manual, publication 1756-UM001	Provides information on how to install, configure, program, and use ControlLogix systems.
Industrial Automation Wiring and Grounding Guidelines, publication 1770-4.1	Provides general guidelines for installing a Rockwell Automation industrial system.
Product Certifications website, rok.auto/certifications .	Provides declarations of conformity, certificates, and other certification details.

You can view or download publications at rok.auto/literature.

Rockwell Automation Support

Use these resources to access support information.

Technical Support Center	Find help with how-to videos, FAQs, chat, user forums, Knowledgebase, and product notification updates.	rok.auto/support
Local Technical Support Phone Numbers	Locate the telephone number for your country.	rok.auto/phonesupport
Technical Documentation Center	Quickly access and download technical specifications, installation instructions, and user manuals.	rok.auto/techdocs
Literature Library	Find installation instructions, manuals, brochures, and technical data publications.	rok.auto/literature
Product Compatibility and Download Center (PCDC)	Download firmware, associated files (such as AOP, EDS, and DTM), and access product release notes.	rok.auto/pcdc





Documentation Feedback

Your comments help us serve your documentation needs better. If you have any suggestions on how to improve our content, complete the form at rok.auto/docfeedback.

Allen-Bradley, ControlLogix, ControlLogix-XT, expanding human possibility, FLEX I/O-XT, and Rockwell Automation are trademarks of Rockwell Automation, Inc. Trademarks not belonging to Rockwell Automation are property of their respective companies.

Rockwell Automation maintains current product environmental compliance information on its website at rok.auto/pec.

Rockwell Otomasyon Ticaret A.Ş. Kar Plaza İş Merkezi E Blok Kat:6 34752, İçerenköy, İstanbul, Tel: +90 (216) 5698400 EEE Yönetmeliğine Uygundur

Connect with us.    

rockwellautomation.com — expanding human possibility[®]

AMERICAS: Rockwell Automation, 1201 South Second Street, Milwaukee, WI 53204-2496 USA, Tel: (1) 414.382.2000, Fax: (1) 414.382.4444

EUROPE/MIDDLE EAST/AFRICA: Rockwell Automation NV, Pegasus Park, De Kleetlaan 12a, 1831 Diegem, Belgium, Tel: (32) 2 663 0600, Fax: (32) 2 663 0640

ASIA PACIFIC: Rockwell Automation, Level 14, Core F, Cyberport 3, 100 Cyberport Road, Hong Kong, Tel: (852) 2887 4788, Fax: (852) 2508 1846

UNITED KINGDOM: Rockwell Automation Ltd. Pitfield, Kilm Farm Milton Keynes, MK11 3DR, United Kingdom, Tel: (44)(1908) 838-800, Fax: (44)(1908) 281-917

Publication 1756-TD005J-EN-P - November 2022

Supersedes Publication 1756-TD005I-EN-P - October 2018

Copyright © 2022 Rockwell Automation, Inc. All rights reserved. Printed in the U.S.A.